

Introduction to NGS Data Analysis on the Ada Cluster

Your Login Password

- Both state of Texas law and TAMU regulations prohibit the sharing and/or illegal use of computer passwords and accounts
- Don't write down passwords
- Don't choose easy to guess/crack passwords
- Change passwords frequently

There will be a 10 minute break halfway through today's short course



For More Help...

Website: hprc.tamu.edu

Email: help@hprc.tamu.edu

Telephone: (979) 845-0219

Visit us in person: Henderson Hall, Room 114A

Help us, help you -- we need more info

- Which Cluster
- UserID/NetID
- Job id(s) if any
- Location of your jobfile, input/output files
- Application used if any
- Module(s) loaded if any
- Error messages
- Steps you have taken, so we can reproduce the problem



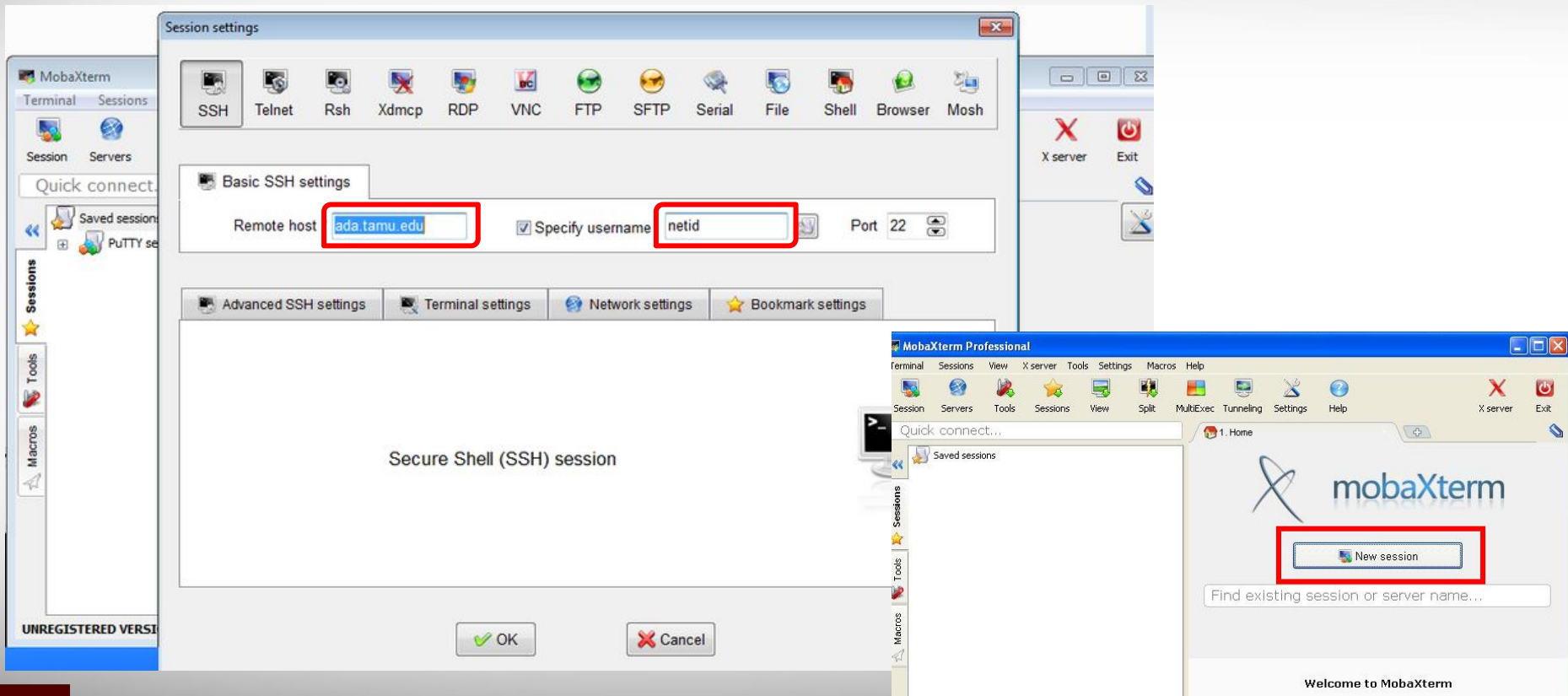

Using SSH - MobaXterm (on Windows)



Next Generation Sequencing (NGS)



Illumina Sequencing Technology

	 MiniSeq System	 MiSeq Series	 NextSeq Series	 HiSeq Series	 HiSeq X Series [†]	 NovaSeq 5000
Key Methods	Amplicon, targeted RNA, small RNA, and targeted gene panel sequencing.	Small genome, amplicon, and targeted gene panel sequencing.	Everyday exome, transcriptome, and targeted resequencing.	Production-scale genome, exome, transcriptome sequencing, and more.	Population- and production-scale whole-genome sequencing.	Same as HiSeq
Maximum Output	7.5 Gb	15 Gb	120 Gb	1500 Gb	1800 Gb	2000 Gb
Maximum Reads per Run	25 million	25 million [†]	400 million	5 billion	6 billion	6.6 billion
Maximum Read Length	2 × 150 bp	2 × 300 bp	2 × 150 bp	2 × 150 bp	2 × 150 bp	2 x 150 bp
Run Time	4–24 hours	4–55 hours	12–30 hours	<1–3.5 days (HiSeq 3000/HiSeq 4000) 7 hours–6 days (HiSeq 2500)	<3 days	19 - 40 hrs
Benchtop Sequencer	Yes	Yes	Yes	No	No	no

<http://www.illumina.com/systems/sequencing-platforms.html>

(Oct 2017)



Illumina Sequencing Technology



↑
 small whole genomes,
 targeted sequencing,
 (non-metagenomic)

illumina.com



Illumina Sequencing Libraries

illumina.com

single end

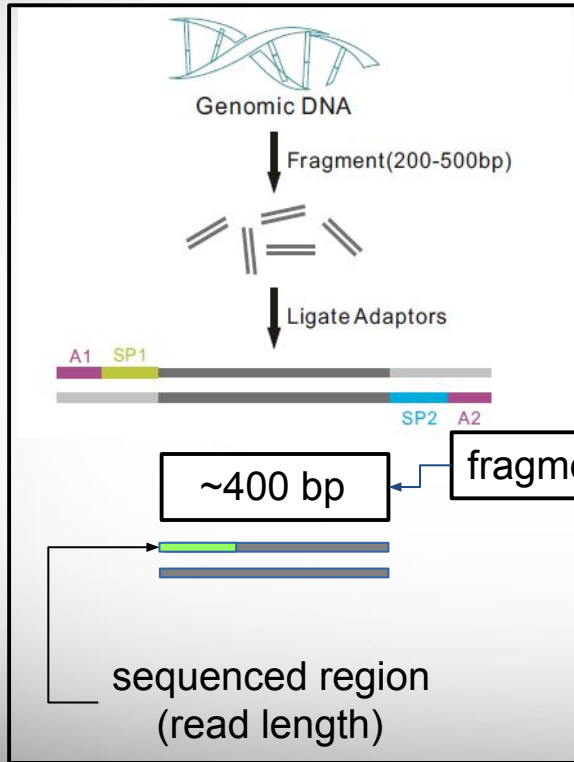

paired ends

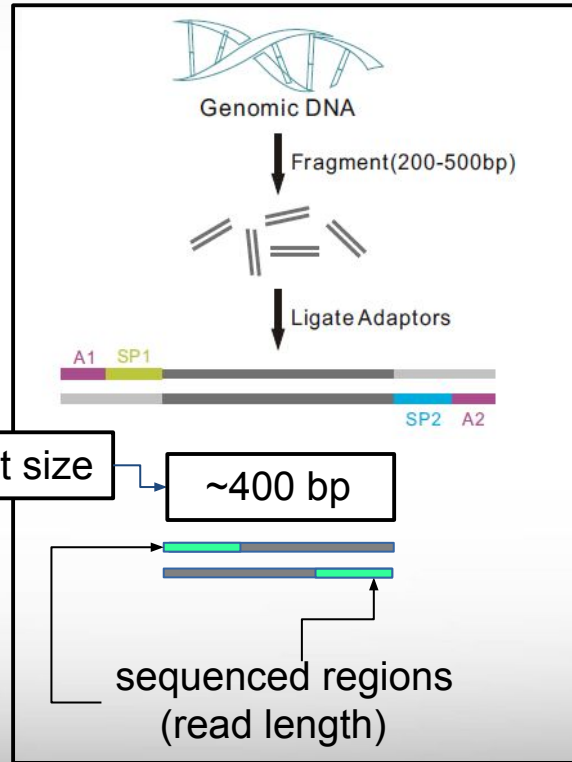

mate pairs

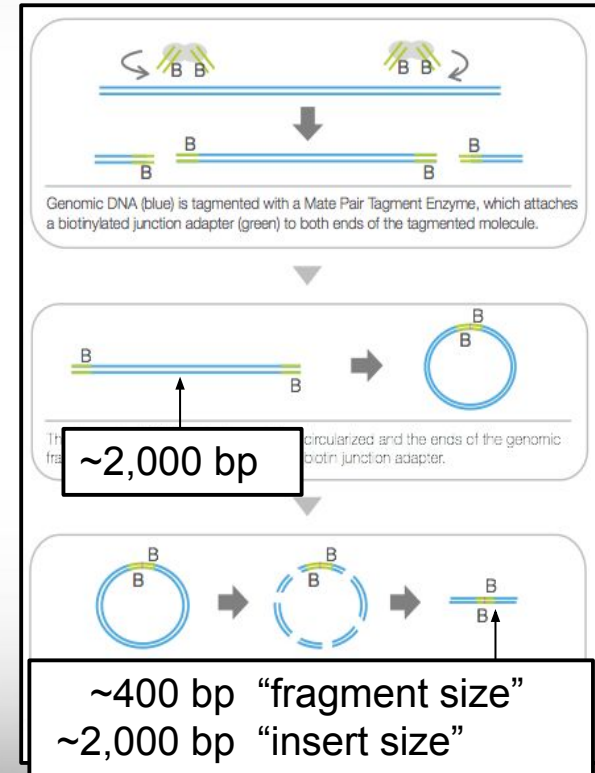

Paired End Reads

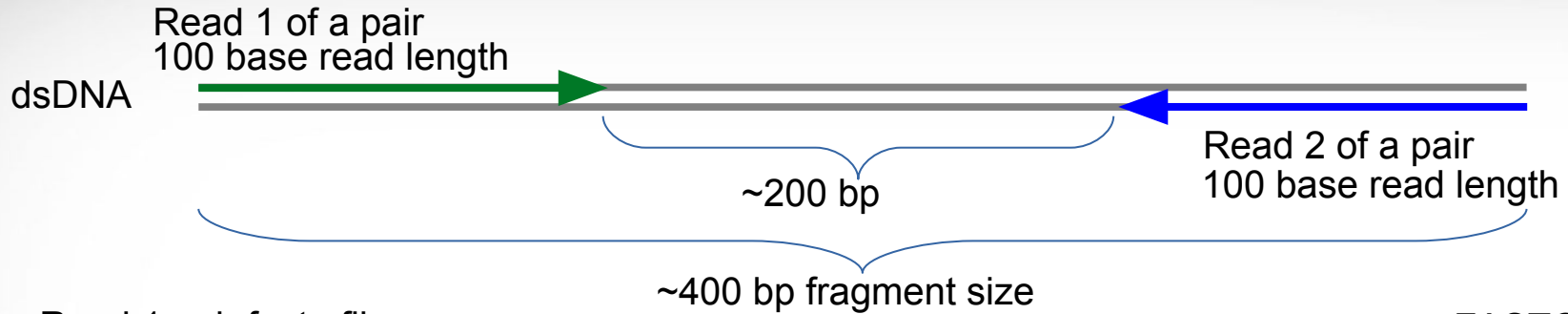

Read 1 pair fastq file

FASTQ format

```
@M00861:1:000000000-A36BE:1:1101:14650:1529 1:N:0:8
TTCTTAAAAATACCATAAAAAGGCTTAAACTTGCCATTTACGACGGATTAATTCCAACCTCTTTTCGGCTATCTTCATCTTTTAAGGT TAAATGACTCATAACGG
+
FFFHBBFFHHIIIIIIHFHHCGEFGHHIHHHIHD/?DGGHHH@DEB,5EGHGHHI IHIF?FGGHHCCBFDGHFHDGHGFFFFGDFHH?DFHDFHHHFHFHFHHH
```

Read 2 pair fastq file

```
@M00861:1:000000000-A36BE:1:1101:14650:1529 2:N:0:8
ACTAAAAATCAATTTTATCAATTTCAAGCTCTACCTTATTTACTCATTTATTTTAGTGATGGCCACTTTAATAAAAAATATTGGTAGCATATTTTGCAATAGCGG
+
BFFHIIHHHFHHDGHIHHIHHHGHHHHHFFHDFHIIHIIHIDFHHHIIHIIH=AAFHII IHFGFHHHHHGGHHIHHFGFFFEGGHHHDGHHH/CGHIFHHH
```

Maintain Read Pair Order

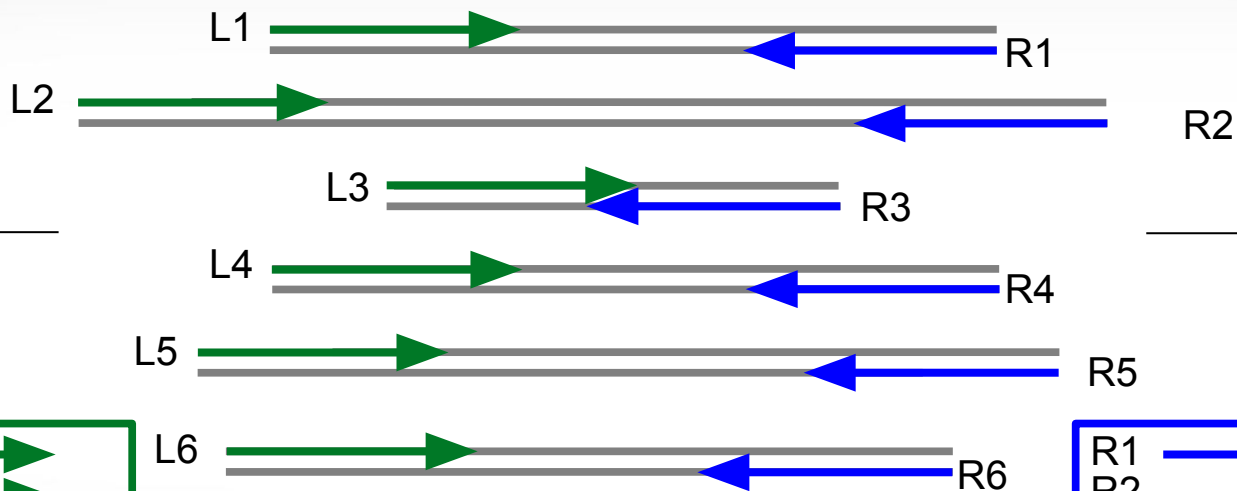

DNA Fragment lengths will be different but
sequence reads may all be the same length

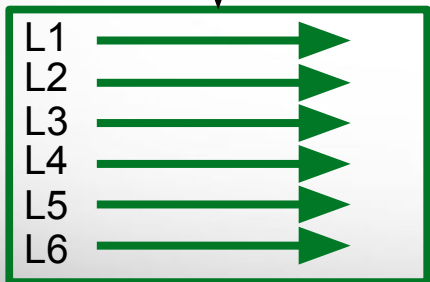

Left Read 1 paired end fastq file

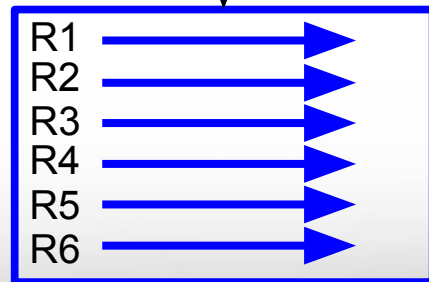

Right Read 2 paired end fastq file

MiSeq Can Perform Initial QC Trimming

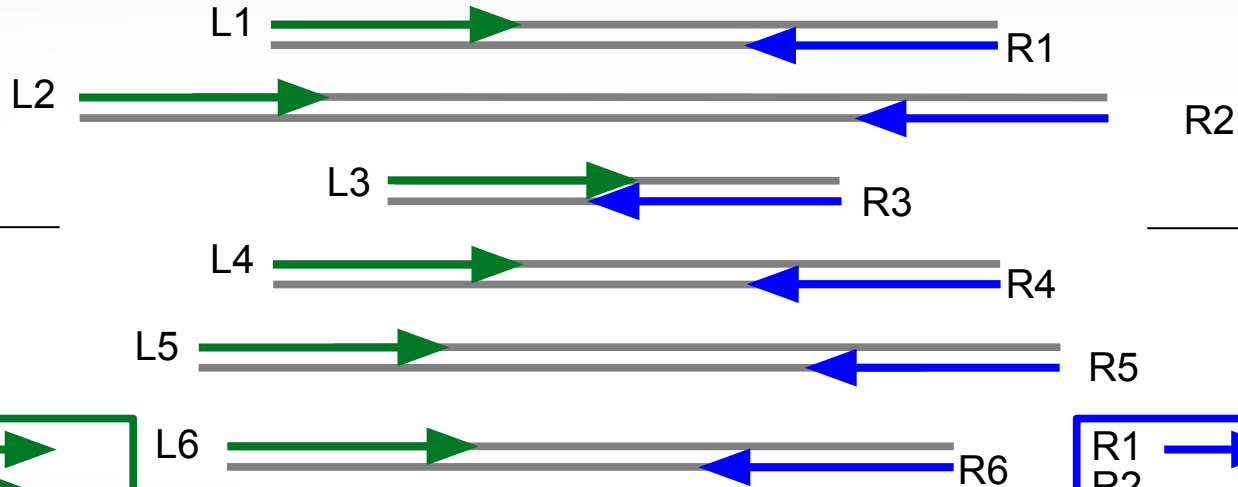

DNA Fragment lengths will be different but
sequence reads can have different lengths

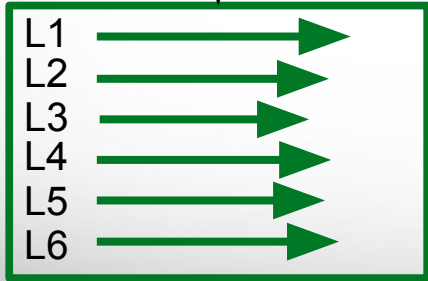

Left Read 1 paired end fastq file

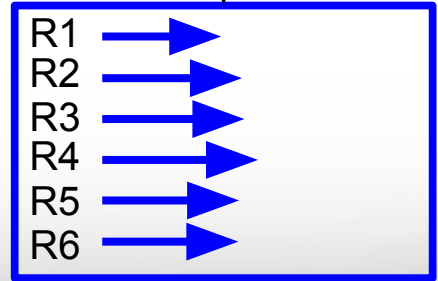

Right Read 2 paired end fastq file

PacBio Long Read Sequencing

Sequel Sequencer

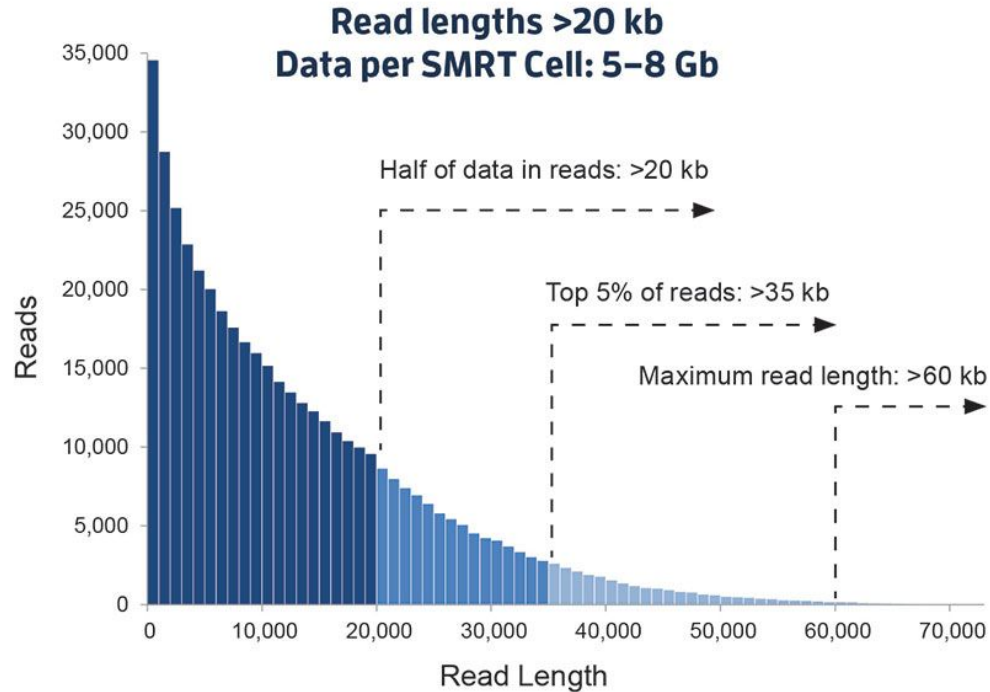

pacb.com



PacBio Long Read Sequencing

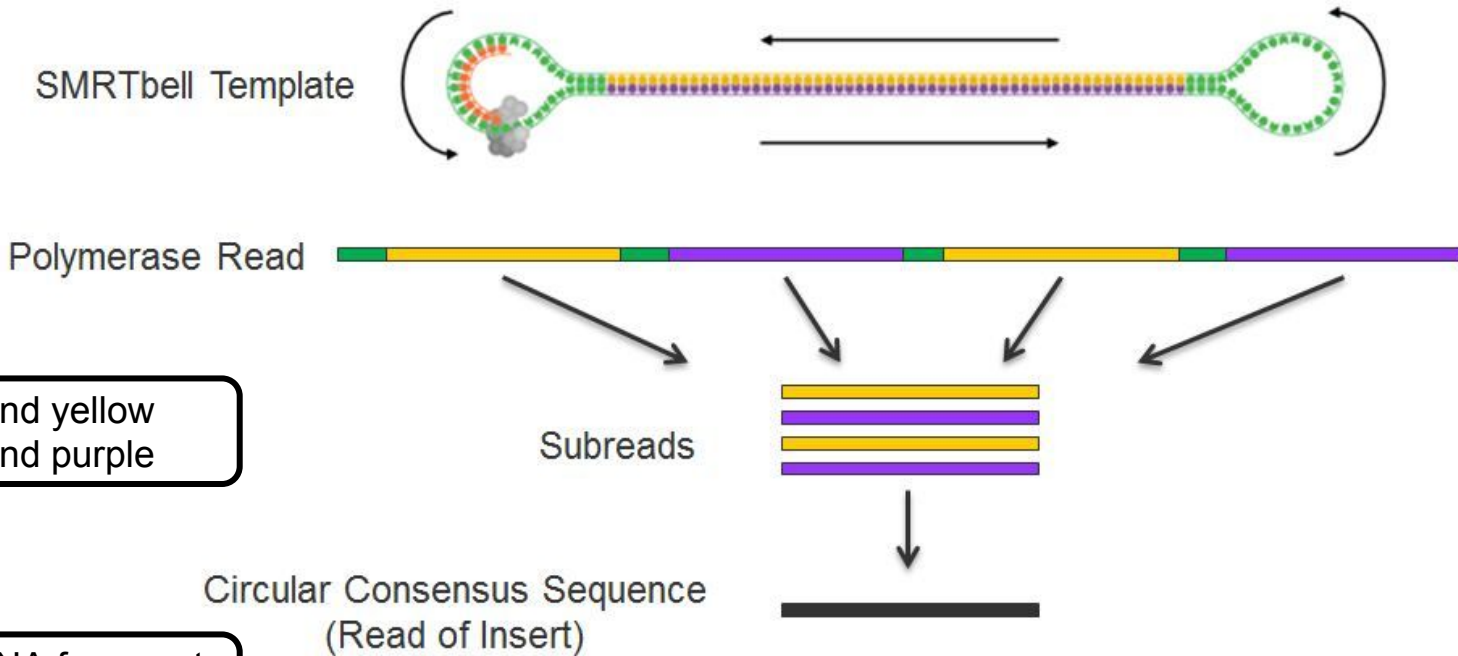

+ Strand yellow
- Strand purple

Shorter DNA fragment equals more subreads

pacb.com



PacBio Sequencing Tools on Ada

- PBSuite
 - PBJelly aligns PacBio reads to draft assemblies
- Proovread and LSC
 - Correct PacBio reads with Illumina reads
 - Computationally intensive
- Canu
 - PacBio long read assembler
 - can be run in grid mode on Curie

https://hprc.tamu.edu/wiki/Ada:NGS:PacBio_tools



NGS Tools on Ada



Where to Find NGS Tools

- TAMU HPRC Documentation
 - <https://hprc.tamu.edu/wiki/index.php/Ada:Bioinformatics>
- Type the following UNIX **commands** to see which tools are already installed on Ada
 - `module avail`
 - `module spider toolname` (not case sensitive, but read the entire output)
 - `module key assembly` (some modules may be missed because this searches tool descriptions)
- If you find a tool that you want installed on Ada, send an email with the URL link to: `help@hprc.tamu.edu`
 - SeqAnswers <http://seqanswers.com/wiki/Software/list>
 - Omictools.com
 - slideshare.net – find shared NGS presentations



Ada Software Toolchains

- Use the same toolchains in your job scripts

Software/**SW.version**-toolchain

```
module load Bowtie2/2.2.6-intel-2015B
module load TopHat/2.1.0-intel-2015B
module load Cufflinks/2.2.1-intel-2015B
```

- Avoid loading mixed toolchains:

```
module load Bowtie2/2.2.2-ictce-6.3.5
module load TopHat/2.0.14-golf-1.7.20
module load Cufflinks/2.2.1-intel-2015B
```

- Avoid loading defaults which may have different toolchains

```
module load Bowtie2 TopHat Cufflinks
```

The GCCcore Toolchain

- To minimize the number of software builds, the GCCcore toolchain modules can be loaded alone or with any one of the following 2017A toolchains
 - intel/2017A
 - iomkl/2017A
 - foss/2017A
- Example of loading a GCCcore module with a 2017A module

```
module load Bowtie2/2.3.3.1-GCCcore-6.3.0
module load TopHat/2.1.1-intel-2017A-Python-2.7.12
```



Python-version-bare modules

- You need to load a non '-bare' Python version along with the -bare module
 - If you do not, then the older default OS Python version will be used
- Used in conjunction with GCCcore builds in order to reduce the number of software modules built.

intel/2017A

iomkl/2017A

foss/2017A

Three Examples of loading GCCcore Python -bare
and a Python module with a 2017A toolchain

1.

```
module load Cython/0.25.2-GCCcore-6.3.0-Python-2.7.12-bare
module load Python/2.7.12-foss-2017A
```

2.

```
module load Cython/0.25.2-GCCcore-6.3.0-Python-2.7.12-bare
module load Python/2.7.12-iomkl-2017A
```

3.

```
module load Cython/0.25.2-GCCcore-6.3.0-Python-2.7.12-bare
module load HISAT2/2.1.0-intel-2017A-Python-2.7.12
```

Loads
Python
indirectly



Use \$TMPDIR whenever possible

- Use the \$TMPDIR if the application you are running can utilize a temporary directory for writing temporary files which are deleted when the job ends
- A temp directory (\$TMPDIR) is automatically assigned for each job which uses the disk(s) on the compute node not the \$SCRATCH shared file system
 - Especially useful when a computational tool writes tens of thousands of temporary files which are deleted when the job is finished and are not needed for the final results
 - This is useful since files on \$TMPDIR will not count against your file quota
 - Don't use \$TMPDIR if your software uses temporary files for restarting where it left off if it should stop before completion
 - Will significantly speed up an mpiBLAST job

```
java -Xmx53g -jar $EBROOTPICARD/FastqToSam.jar TMP_DIR=$TMPDIR \  
FASTQ=$pe1_1 FASTQ2=$pe1_2 OUTPUT=$outfile SAMPLE_NAME=$sample_name \  
SORT_ORDER=$sort_order MAX_RECORDS_IN_RAM='null'
```



Template Job Scripts



Access GCATemplate Scripts for Ada

https://hprc.tamu.edu/wiki/index.php/Ada:NGS:Sequence_QC#FastQC

Evaluation

FastQC
GCATemplates available: yes

```
module load FastQC/0.11.5-Java-1.7.0_80
```

After running FastQC via the command line, you can ssh to Ada enabling X11 forwarding by using the -X option and view the images using the eog tool.

From your desktop:

```
ssh -X username@ada.tamu.edu
```

From your FastQC working directory on Ada unzip the .zip results file then use eog to view the results in the Images directory:

```
eog sample_fastqc/Images/per_sequence_gc_content.png
```

You can also run FastQC interactively using the FastQC GUI by logging in using X11 forwarding and running the command:

```
fastqc
```

RNA-SeQC
GCATemplates available: yes

Click to see template script on github

Genomic Computational
Analysis Templates



GCATemplates/run_fastqc_0.11.5_ada.sh at master · cmdickens/GCATemplates - Mozilla Firefox

https://github.tamu.edu/cmdickens/GCATemplates/blob/mast

This repository Search Pull requests Issues Gist

cmdickens / GCATemplates Unwatch 1 Star 0 Fork 0

Code Issues 0 Pull requests 0 Wiki Pulse Graphs Settings

Branch: master GCATemplates / templates / ada / run_fastqc_0.11.5_ada.sh Find file Copy path

cmdickens update fastqc-trimmio 51038b1 a day ago

1 contributor

Executable File 37 lines (29 sloc) 1.86 KB Raw Blame History

```

1 #BSUB -L /bin/bash # uses the bash login shell to initialize the job's execution environment.
2 #BSUB -J fastqc # job name
3 #BSUB -n 2 # assigns 2 cores for execution
4 #BSUB -R "span[ptile=2]" # assigns 2 cores per node
5 #BSUB -R "rusage[mem=2000]" # reserves 2000MB memory per core
6 #BSUB -M 2000 # sets to 2000MB process enforceable memory limit. (M * n)
7 #BSUB -W 1:00 # sets to 1 hour the job's runtime wall-clock limit.
8 #BSUB -o stdout.%J # directs the job's standard output to stdout.jobid
9 #BSUB -e stderr.%J # directs the job's standard error to stderr.jobid
10
11 module load FastQC/0.11.5-Java-1.7.0_80
12
13 <<README
14 - FASTQC homepage: http://www.bioinformatics.babraham.ac.uk/projects/fastqc/
15 - FASTQC manual: http://www.bioinformatics.babraham.ac.uk/projects/fastqc/Help/
16 README
17
18 =====
19 # TODO Edit these variables as needed:
20 threads=2 # make sure this is <= your BSUB -n value
21
22 pe1_1='/scratch/datasets/GCATemplates/data/miseq/c_dublinsiensis/DR34_R1.fastq.gz'
23 pe1_2='/scratch/datasets/GCATemplates/data/miseq/c_dublinsiensis/DR34_R2.fastq.gz'
24
25 =====

```



Finding NGS job template scripts using GCATemplates on Ada

Genomic Computational Analysis Templates

```
mkdir $SCRATCH/ngs_class
```

```
cd $SCRATCH/ngs_class
```

```
module load GCATemplates
```

```
gcatemplates
```

For practice, we will copy a template file

- Select #4 then find the template that contains fastqc
- Final step will save a template job script file to your current working directory
- After you save the template file:

```
module purge
```

```
BIOINFORMATICS GCATemplates (ada)

CATEGORY
1. BAM files
2. ChIP-seq
3. FASTA files
4. FASTQ files (QC, trim, SRA)
5. Functional genomics
6. Genome assembly
7. Genotyping/Serotyping
8. Metagenomics
9. Oxford Nanopore tools
10. PacBio tools
11. Phylogenetics
12. Population genetics
13. RNA-seq
14. SNPs & indels
15. Sequence alignments
16. Simulate data

s search
q quit

Select:4
```

Sample GCATemplate Job Script (Ada)

```
#BSUB -L /bin/bash
```

```
#BSUB -J blastx
```

```
#BSUB -n 1
```

```
#BSUB -R "span[ptile=1]"
```

```
#BSUB -R "rusage[mem=2500]"
```

```
#BSUB -M 2500
```

```
#BSUB -W 2:00
```

```
#BSUB -o stdout.%J
```

```
#BSUB -e stderr.%J
```

```
module load BLAST+/2.2.31-intel-2015B-Python-3.4.3
```

```
<<README
```

```
BLAST manual: http://www.ncbi.nlm.nih.gov/books/NBK279690/
```

```
README
```

```
# blastx: search protein databases using a translated nucleotide query
```

```
blastx -query mrna_seqs_nt.fasta -db /scratch/datasets/blast/nr \  
-outfmt 10 -out mrna_seqs_nt_blastout.csv
```



Sample GCATemplate Job Script (Ada)

```
#BSUB -L /bin/bash
#BSUB -J blastx
#BSUB -n 1
#BSUB -R "span[ptile=1]"
#BSUB -R "rusage[mem=2500]"
#BSUB -M 2500
#BSUB -W 2:00
#BSUB -o stdout.%J
#BSUB -e stderr.%J
```

These parameters are read by the job scheduler

Load the required module(s) first

```
module load BLAST+/2.2.31-intel-2015B-Python-3.4.3
```

This is a section of comments

```
<<README
```

```
BLAST manual: http://www.ncbi.nlm.nih.gov/books/NBK279690/
```

```
README
```

This is a single line comment and not run as part of the script

```
# blastx: search protein databases using a translated nucleotide query
```

This is the command to run the application

```
blastx -query mrna_seqs_nt.fasta -db /scratch/datasets/blast/nr \
-outfmt 10 -out mrna_seqs_nt_blastout.csv
```

**This means the command is continued on the next line; The space before the \ is required Do not put a space after the **



Quality Control (QC)



QC Evaluation

- Use FastQC to visualize quality scores
 - Displays quality score distribution of a subset of ~200,000 reads
 - Input is a fastq file or files
 - Can disable grouping (binning) of sequence regions
 - Will alert you of poor read characteristics
 - Can be run as a GUI or a command line interface

```
module load FastQC/0.11.6-Java-1.8.0
```

- FastQC will process using one CPU core per file
 - If there are 10 fastq files to analyze and 4 cores used
 - 4 files will start processing and 6 will wait in a queue
 - If there is only one fastq file to process then using 10 cores does not speed up the process

FastQC Exercise

- Use the GCATemplate for FastQC to submit a job evaluating the two sequence files
 - `gedit run_fastqc_0.11.6_ada.sh &`
 - `bsub < run_fastqc_0.11.6_ada.sh`
- After your fastqc job is complete, unzip the results file and you can view the results files with `lynx` and `eog` (eog requires X11 login)
 - `unzip DR34_R1_fastqc.zip`



FastQC Report using lynx

```
DR34_R1.fastq.gz FastQC Report (pl of 4)
FastQC FastQC Report
Wed 9 Mar 2016
DR34_R1.fastq.gz

Summary
* [PASS] Basic Statistics
* [PASS] Per base sequence quality
* [PASS] Per tile sequence quality
* [PASS] Per sequence quality scores
* [FAIL] Per base sequence content
* [PASS] Per sequence GC content
* [PASS] Per base N content
* [WARNING] Sequence Length Distribution
* [PASS] Sequence Duplication Levels
* [WARNING] Overrepresented sequences
* [PASS] Adapter Content
* [FAIL] Kmer Content

[OK] Basic Statistics

Measure Value
Filename DR34_R1.fastq.gz
File type Conventional base calls
Encoding Sanger / Illumina 1.9
Total Sequences 946744
Sequences flagged as poor quality 0
Sequence length 35-251
%GC 39

-- press space for next page --
Arrow keys: Up and Down to move. Right to follow a link; Left to go back.
H)elp O)ptions P)rint G)o M)ain screen Q)uit /=search [delete]=history list
```

lynx DR34_R1_fastqc.html



FastQC Output Image Quality Distribution

eog DR34_R1_fastqc/Images/per_base_quality.png

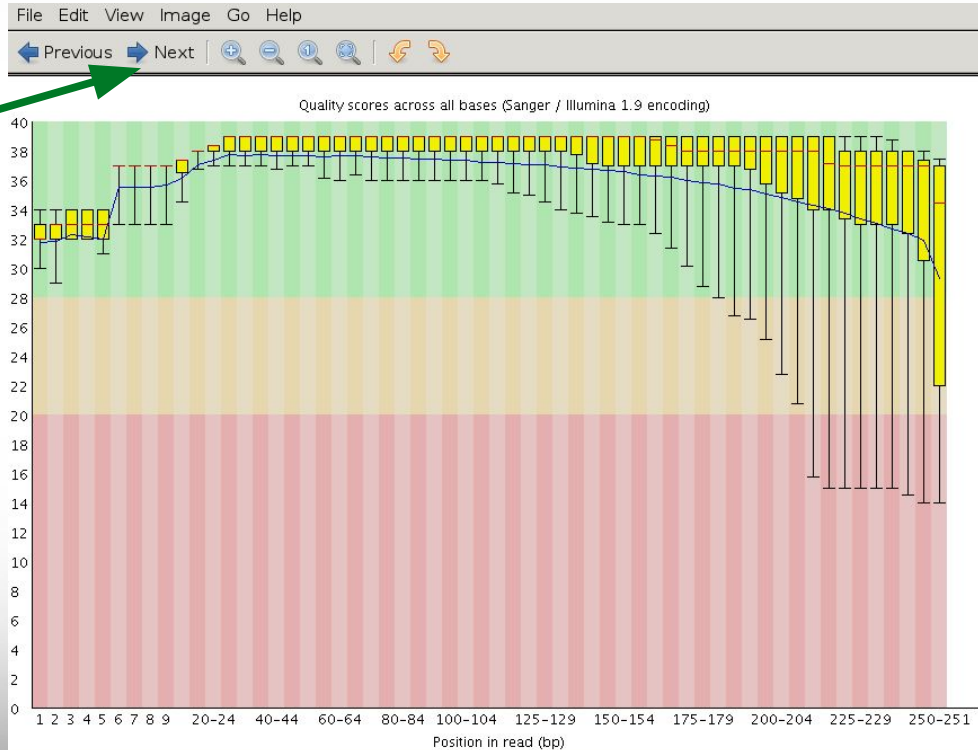

click for the next image in the same directory, or use the left/right arrow keys

Prior to QC trimming

FastQC Output Image Quality Distribution

FASTQ format

```
@ERR504787.2.1 M00368:15:000000000-A0HKH:1:5:21261:10968-1 length=100
GATCGGAAGAGCACACGTCTGAACTCCAGTCACGATCAGATCTCGTATGCCGTCTTCTGCTTGAAAAA
+ERR504787.2.1 M00368:15:000000000-A0HKH:1:5:21261:10968-1 length=100
==4AD=B8A:+<A: :1<:AE<C3*?F<B???<?:8:6?B*9BD;/638.-'-.@7=) .=A:6?DDDCB
@ERR504787.3.1 M00368:15:000000000-A0HKH:1:3:12724:25677-1 length=100
GATGTTTTGTTACTGATTGGAACCATGATTGGTGCTTTACTTGGTTTCTTCCTATTTAACCACAAGCCT
+ERR504787.3.1 M00368:15:000000000-A0HKH:1:3:12724:25677-1 length=100
BCCFDEFFHHHHHJJJJJJJJJJJJJJJJJJJJJJJJJJJJJJJJJJJJJJJJJJJJJJJJJJJJJJJJ
@ERR504787.5.1 M00368:15:000000000-A0HKH:1:2:16161:12630-1 length=100
TATTTTAAAGTGACCAAGGAATGACTCCCAATCATGGCTGTATCAACTCCAAAATTTTCTGCAACAGT
+ERR504787.5.1 M00368:15:000000000-A0HKH:1:2:16161:12630-1 length=100
CCCCFFFFHHHHHJJJJJJJJJJJJJJJJJJJJJJJJJJJJJJJJJJJJJJJJJJJJJJJJJJJJJJJJ
```

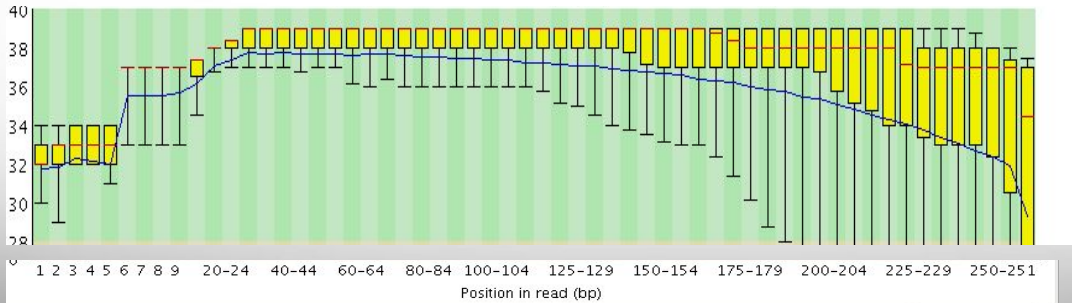

FastQC Output Image Quality Distribution

FASTQ format

```
@ERR504787.2.1 M00368:15:000000000-A0HKH:1:5:21261:10968-1 length=100
GATCGGAAGAGCACACGTCTGAACTCCAGTCACGATCAGATCTCGTATGCCGTCTTCTGCTTGAAAAA
+ERR504787.2.1 M00368:15:000000000-A0HKH:1:5:21261:10968-1 length=100
==4AD=B8A:+<A: :1<:AE<C3*?F<B???<?:8:6?B*9BD;/638.=-'-.@7=) .=A:6?DDDCBB
@ERR504787.3.1 M00368:15:000000000-A0HKH:1:3:12724:25677-1 length=100
GATGTTTTGTTACTGATTGGAACCATGATTGGTGCTTTACTTGGTTTCTTCCTATTTAACCACAAGCCTGC
+ERR504787.3.1 M00368:15:000000000-A0HKH:1:3:12724:25677-1 length=100
BCCFDEFFHHHHJJJJJJJJJJJJJJJJJJJJJJJJJJJJJJJJJJJJJJJJJJJJJJJJJJJJJJJJJJJJ
@ERR504787.5.1 M00368:15:000000000-A0HKH:1:2:16161:12630-1 length=100
TATTTTAAAGTGACCAAGGAATGACTCCCAATCATGGCTGTATCAACTCCAAAATTTTCTGCAACAGTCGCTG
+ERR504787.5.1 M00368:15:000000000-A0HKH:1:2:16161:12630-1 length=100
CCCCFFFFHHHHJJJJJJJJJJJJJJJJJJJJJJJJJJJJJJJJJJJJJJJJJJJJJJJJJJJJJJJJJJJJ
```

Average quality score distribution at position one

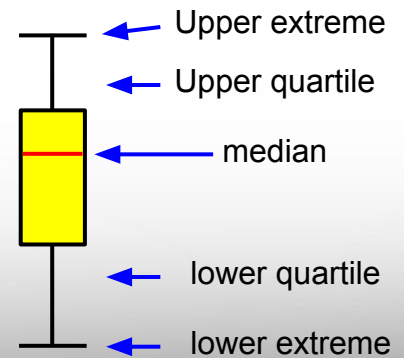
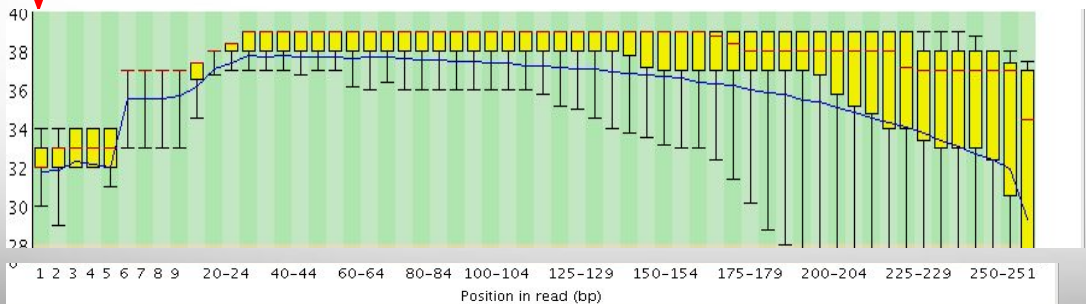

FastQC Output Image Quality Distribution

FASTQ format

```
@ERR504787.2.1 M00368:15:000000000-A0HKH:1:5:21261:10968-1 length=100
GATCGGAAGAGCACACGTCTGAACTCCAGTCACGATCAGATCTCGTATGCCGTCTTCTGCTTGAAAAA
+ERR504787.2.1 M00368:15:000000000-A0HKH:1:5:21261:10968-1 length=100
==:4AD=B8A:++A::1<:AE<C3*?F<B???<?:8:6?B*9BD;/638.-'-.@7=) .=A:6?DDDCBB
@ERR504787.3.1 M00368:15:000000000-A0HKH:1:3:12724:25677-1 length=100
GATGTTTTGTTACTGATTGGAACCATGATTGGTGCTTTACTTGGTTTCTTCCTATTTAACCACAAGCCT
+ERR504787.3.1 M00368:15:000000000-A0HKH:1:3:12724:25677-1 length=100
BCCFDEFFHHHHJJJJJJJJJJJJJJJJJJJJJJJJJJJJJJJJJJJJJJJJJJJJJJJJJJJJJJJJJJ
@ERR504787.5.1 M00368:15:000000000-A0HKH:1:2:16161:12630-1 length=100
TATTTTAAGTGACCAAGGAATGACTCCCAATCATGGCTGTATCAACTCCAAAATTTTCTGCAACAGTCG
+ERR504787.5.1 M00368:15:000000000-A0HKH:1:2:16161:12630-1 length=100
CCCFHHHHJJJJJJJJJJJJJJJJJJJJJJJJJJJJJJJJJJJJJJJJJJJJJJJJJJJJJJJJJJJJ
```

Positions are 'binned' after the first few positions

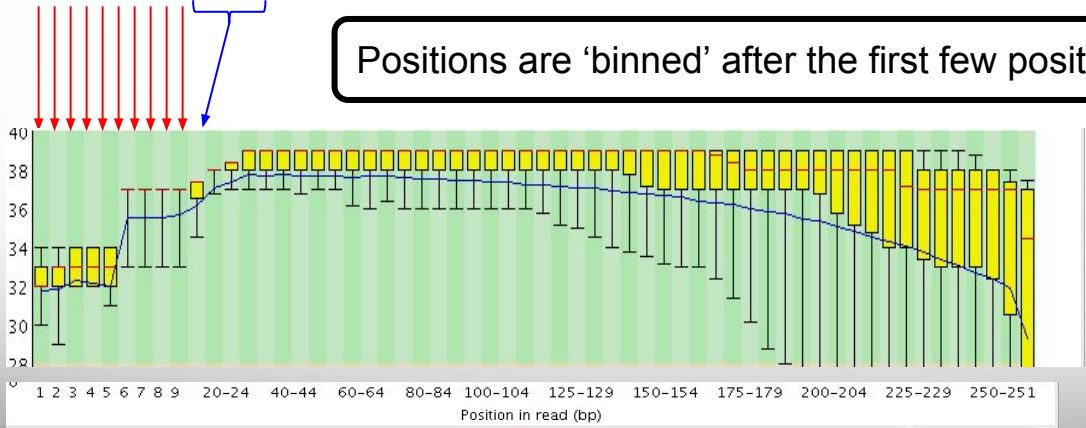

Illumina Transposon Insertion Site

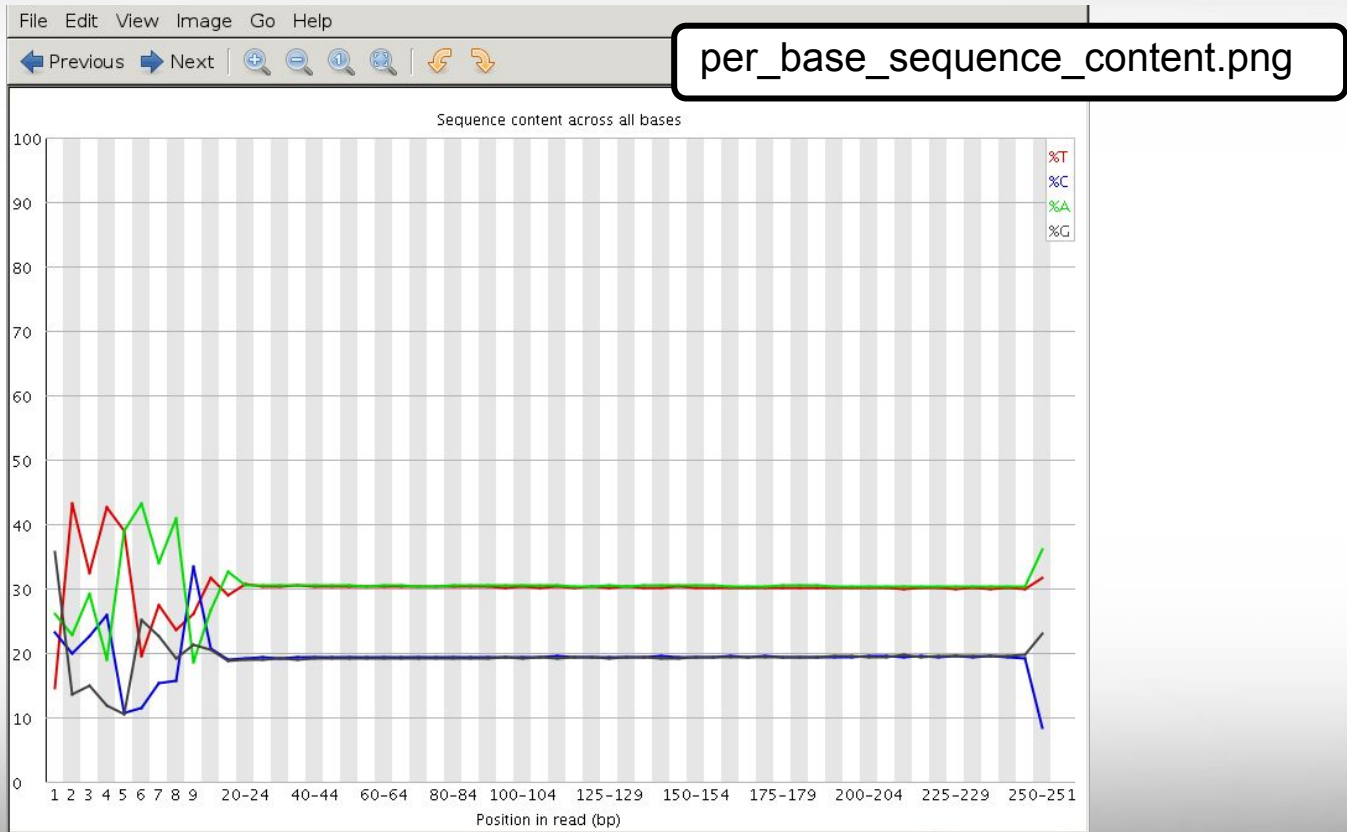

Illumina Transposon Insertion Site

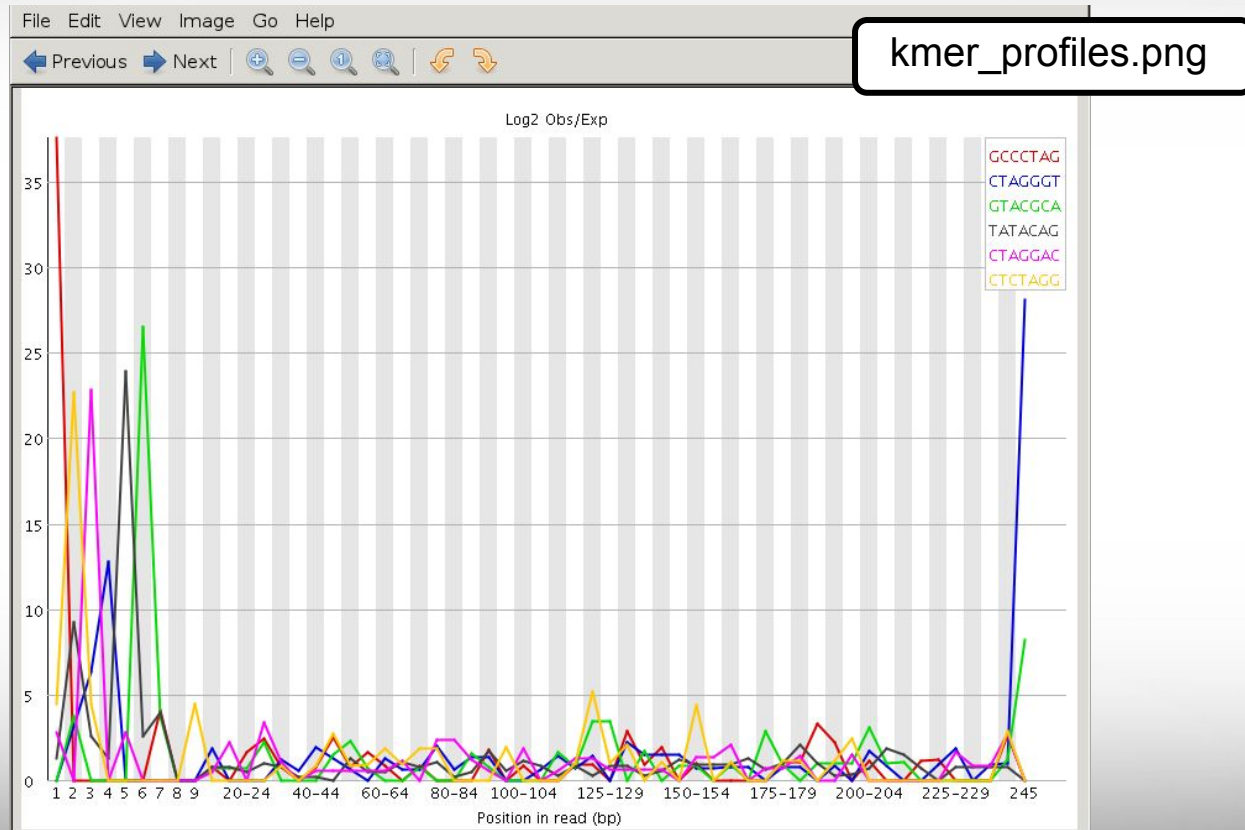

kmer_profiles.png



FastQC Flowcell Quality Image

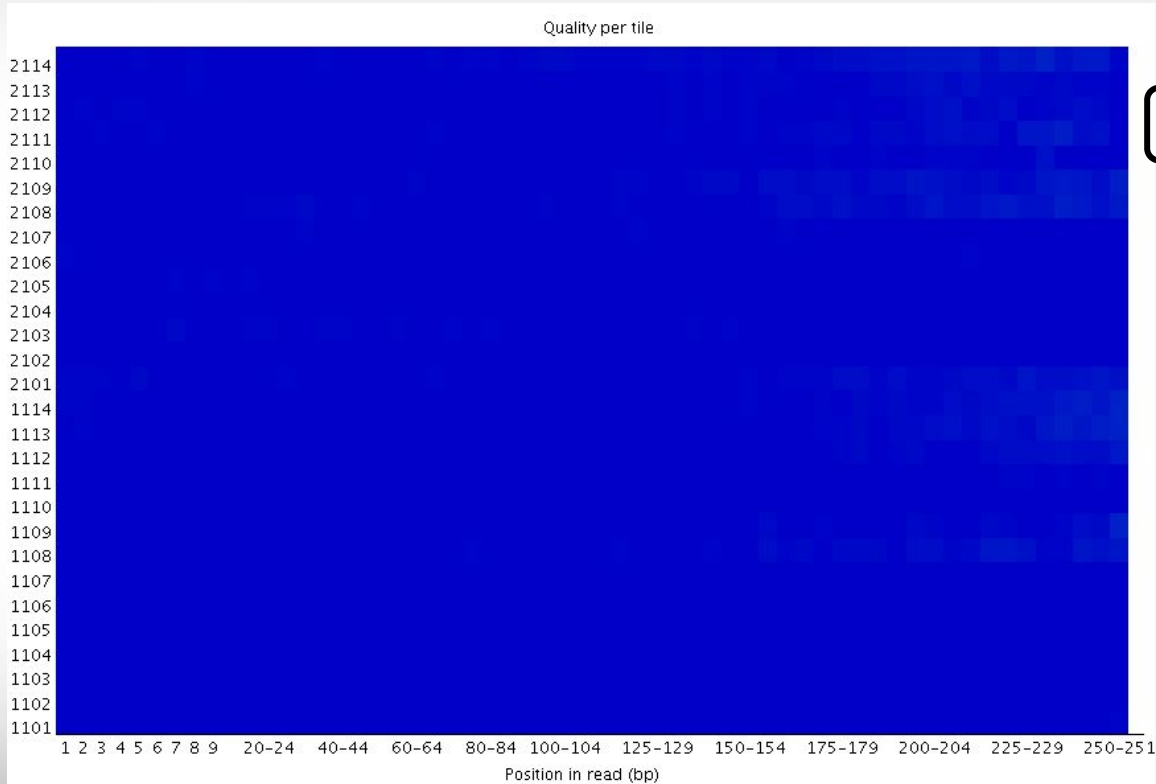

per_tile_quality.png

Flowcell quality mapping
Good per_tile quality

MiSeq flowcell

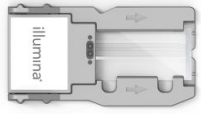

good quality



poor quality

FastQC Flowcell Quality Image

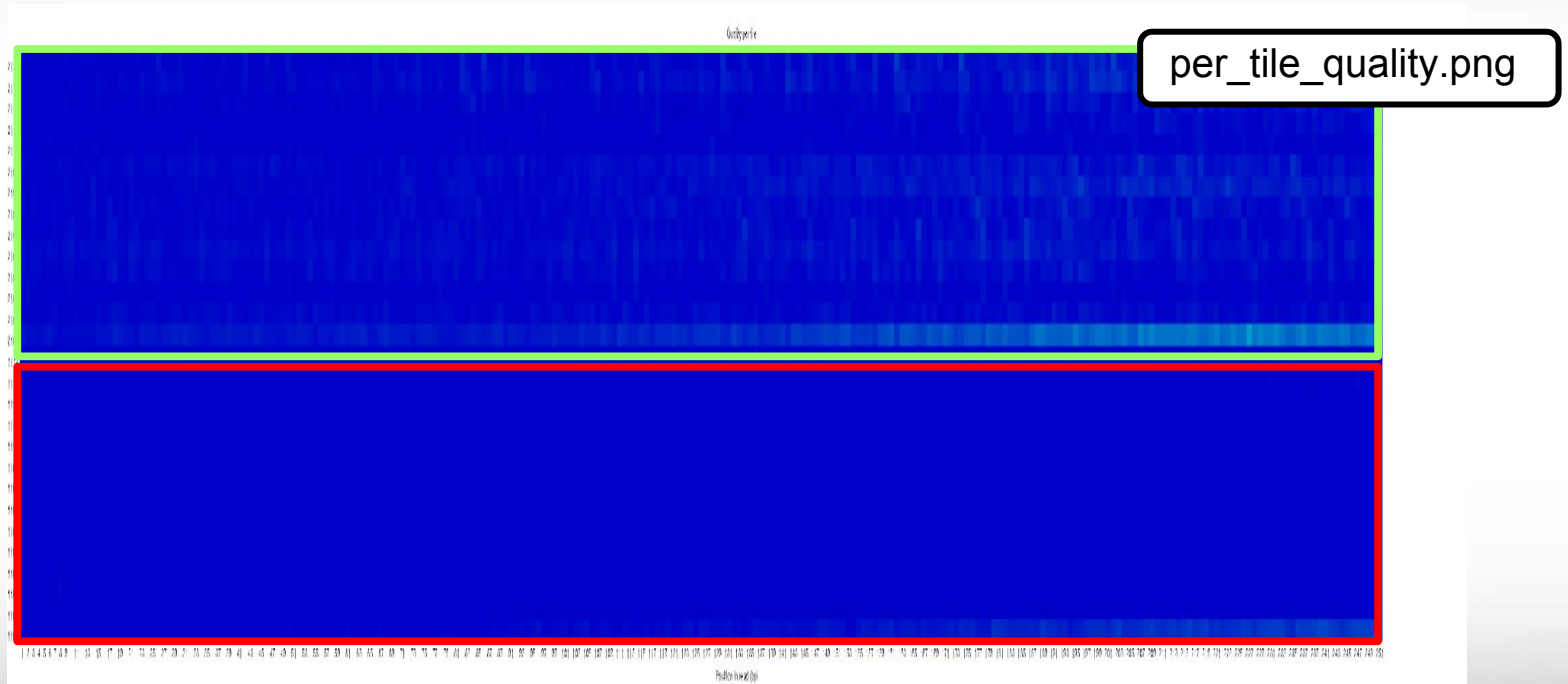

Failed QC Examples



FastQC Output Image

Failed Per base sequence quality

Example 1. Expired MiSeq mate-pair kit (9 months expired)

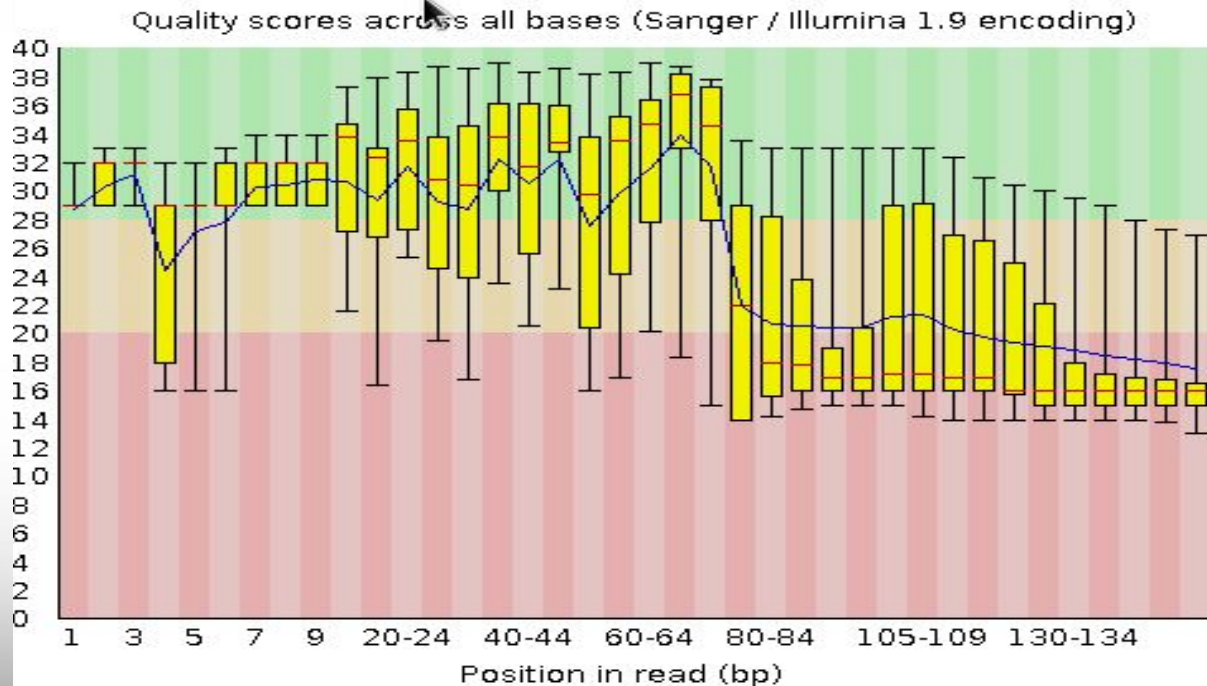

FastQC Output Image

Failed Kmer Content

Example 2. Sequence prep adapters still on ends of DNA library fragments

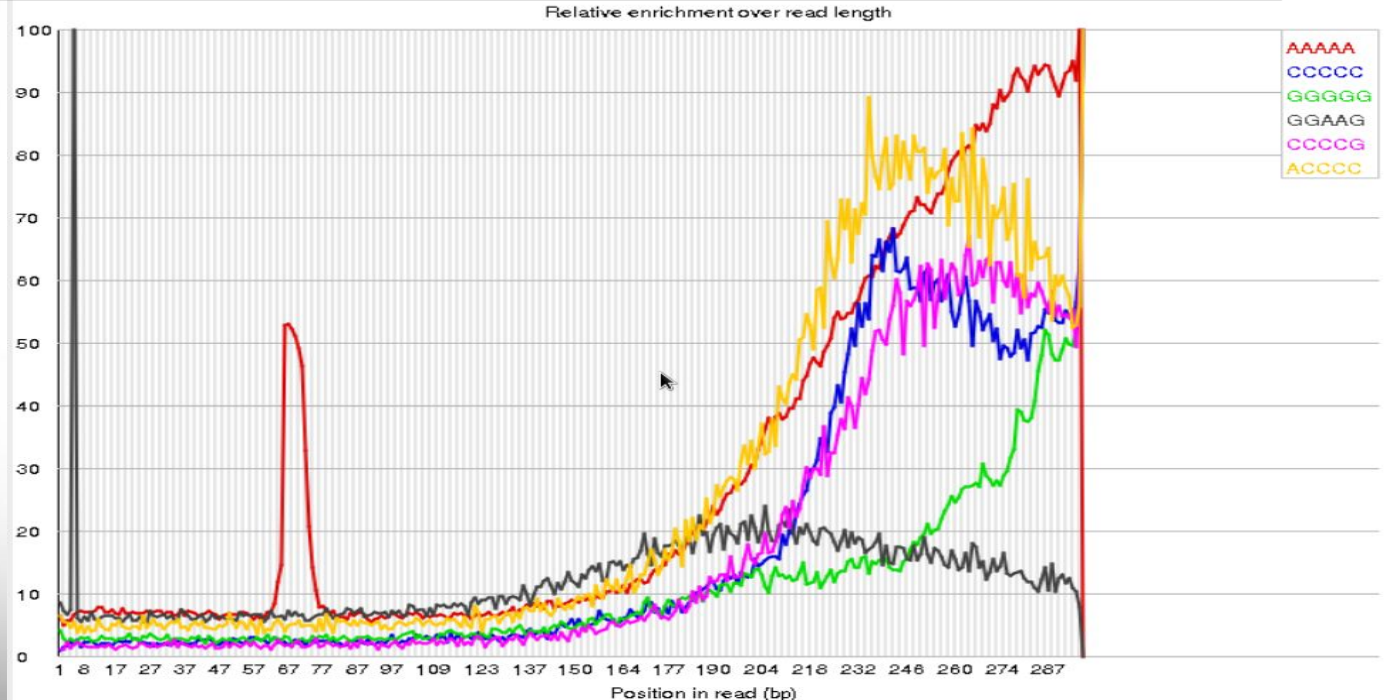

FastQC Output Image

Flowcell: not good per_tile quality

Example 3. Faulty flowcell

MiSeq flowcell

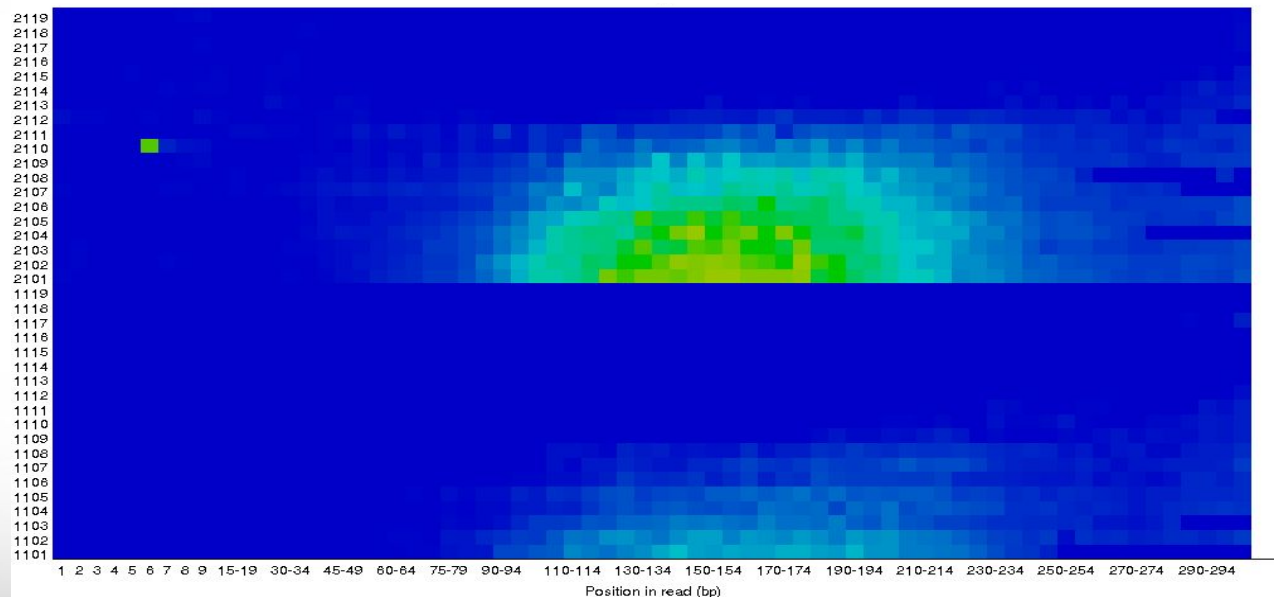
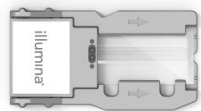

good quality  poor quality

QC Quality Trimming

- Sequence quality trimming tools

```
module spider Trimmomatic
```

← recommended tool

- Trimmomatic will maintain paired end read pairing after trimming
- Trim reads based on quality scores
 - Trim the same number of bases from each read or
 - Use a sliding window to calculate average quality at ends of sequences
- Decide if you want to discard reads with Ns
 - some assemblers replace Ns with As or a random base G, C, A or T
- Trim adapter sequences
 - Trimmomatic has a file of Illumina adapter sequences

```
module load Trimmomatic/0.38-Java-1.8.0
```

```
ls $EBROOTTRIMMOMATIC/adapters/
```

Paired End Short Reads

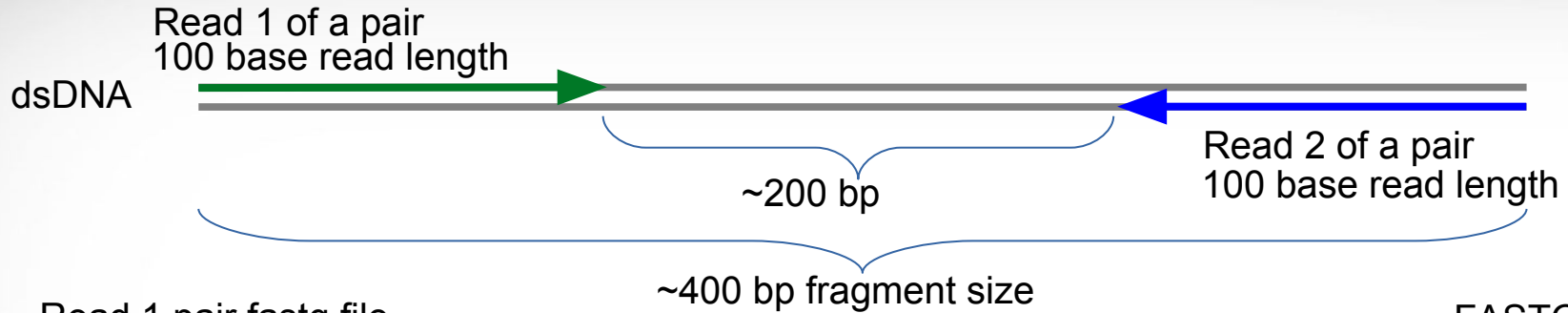

Read 1 pair fastq file

FASTQ format

```
@M00861:1:000000000-A36BE:1:1101:14650:1529 1:N:0:8
TTCTTAAAAATACCATAAAAGGCTTAAACTTGCCATTTACGACGGATTAATTCCAACCTTTTTCGGCTATCTTCATCTTTAAGGTAAATGACTCATAACGG
+
FFFHBBFFHHIIIIIIHFHHCGEFGHHIHHHIHD/?DGGHHH@DEB,5EGHGHIIHIF?FGGHHCCBFDGHFHDGHGFFFFGDFHH?DFHDFHHHFHFFHHH
```

Read 2 pair fastq file

```
@M00861:1:000000000-A36BE:1:1101:14650:1529 2:N:0:8
ACTAAAAATCAATTTTATCAATTTCAAGCTCTACCTTATTTACTCATTATTTTAGTGATGGCCACTTTAATAAAAAATATTGGTAGCATATTTGCAATAGCGG
+
BFFHIHHHFHHDGHIHHIHHHGHHHHHFFHDFHHIHI I IHIHDFHHHIHI I IH-AAFHI I IHFGFHHHHHGGHHIHHFGFFFEGGHHHDGHHH/CGHIFHHH
```

dsDNA



Trimming PE Short Sequence Reads

File 1 from sequencer



100 bases



100 bases

File 2 from sequencer

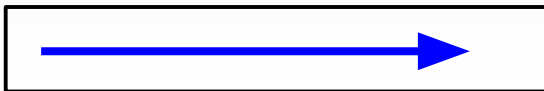

100 bases

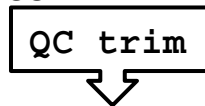

50 bases

minimum read length = 40

Resulting FASTQ Files with trimmed reads

Paired end 1 trimmed file



Paired end 2 trimmed file



dsDNA



Trimming PE Short Sequence Reads

File 1 from sequencer



100 bases



100 bases

File 2 from sequencer

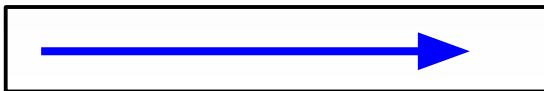

100 bases

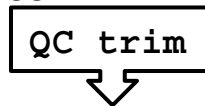

20 bases

minimum read length = 40

Resulting FASTQ Files with trimmed reads

Paired end 1 trimmed file



Paired end 2 trimmed file



Single end reads



Merge Overlapping Paired End Short Reads

fragment 1

dsDNA



fragment 2

dsDNA



Merge Overlapping Paired End Short Reads

fragment 1



fragment 2

dsDNA



Paired end read 1 (left)



Paired end read 2 (right)



Merge Overlapping Paired End Short Reads

fragment 1

dsDNA



fragment 2

dsDNA



Paired end read 1 (left)



Paired end read 2 (right)

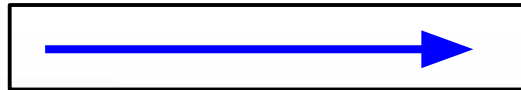

Unpaired 'merged' read



Tools for merging overlapping reads:

`module spider FLASH`

`module spider Coperead`

`module spider PEAR`

Trimmomatic Exercise using GCATemplates on Ada

Genomic Computational Analysis Templates

```
gcatemplates
```

For practice, we will copy a template file

- Select #4 then find the template that contains trimmomatic
- Save the template script to your pwd
- Review the template script contents
- submit the template script to the scheduler
- Review the output files

```
BIOINFORMATICS GCATemplates (ada)

CATEGORY
1. BAM files
2. ChIP-seq
3. FASTA files
4. FASTQ files (QC, trim, SRA)
5. Functional genomics
6. Genome assembly
7. Genotyping/Serotyping
8. Metagenomics
9. Oxford Nanopore tools
10. PacBio tools
11. Phylogenetics
12. Population genetics
13. RNA-seq
14. SNPs & indels
15. Sequence alignments
16. Simulate data

s search
q quit

Select:4
```

Mapping Reads to a Reference Assembly



Mapping Reads to a Reference Assembly

- Align reads using bwa

- `module spider BWA`

- bwa index files for UCSC genomes found here

- `/scratch/datasets/genome_indexes/ucsc/mm10/bwa_0.7.12_index/`

- Align reads using bowtie or bowtie2

- `module spider Bowtie`

- Bowtie index files for UCSC genomes found here:

- `/scratch/datasets/genome_indexes/ucsc/mm10/bowtie_index/`

- `module spider Bowtie2`

- Bowtie2 index files for UCSC found here:

- `/scratch/datasets/genome_indexes/ucsc/mm10/bowtie2_index/`

Visualize bam File Alignments



Sample bam and reference files

```
cd $SCRATCH/ngs_class
```

For this samtools demo, add symbolic links* to the example files in your working directory

```
ln -s /scratch/training/intro_to_ngs/alignments/dr34.sam
```

Add a symbolic link to the example reference genome fasta file

```
ln -s /scratch/training/intro_to_ngs/genomes/c_dublinsiensis.fa
```

Use the tab key when typing these long paths

* The symbolic links are used to make the commands shorter for demonstration purposes only. You do not need to make symbolic links in order to use `samtools tview`



Sorting Alignment sam/bam Files

- Sequence Alignment/Map format (sam)
 - view sam files using the UNIX command: `more dr34.sam`
- Binary Alignment/Map format (bam)
 - Compressed (binary) sam files need samtools to view
 - `module load SAMtools/1.7-GCCcore-6.3.0`
 - Recommended: sort sam/bam file based on coordinate into bam format
 - `samtools sort -@ 1 -m 2G -o dr34.bam dr34.sam`
 - Create an index of the bam file using samtools
 - A samtools index is needed prior to viewing bam files in browsers

```
samtools index dr34.bam
```

```
dr34.bam.bai
```

Viewing sam/bam Files

Viewing bam files using samtools

```
samtools view dr34.bam | more
```

view only alignments

```
samtools view -H dr34.bam
```

view only header

```
samtools view -h dr34.bam | more
```

view header + alignments



Alignment Statistics

```
samtools flagstat dr34.bam
```

```
150000 + 0 in total (QC-passed reads + QC-failed reads)
0 + 0 secondary
0 + 0 supplementary
0 + 0 duplicates
140150 + 0 mapped (93.43% : N/A)
150000 + 0 paired in sequencing
75002 + 0 read1
74998 + 0 read2
85639 + 0 properly paired (57.09% : N/A)
136854 + 0 with itself and mate mapped
3296 + 0 singletons (2.20% : N/A)
909 + 0 with mate mapped to a different chr
56 + 0 with mate mapped to a different chr (mapQ>=5)
```

Both reads in the pair are mapped
on the same chromosome
and in FR or RF orientation



Sam Flags and Bits

<https://broadinstitute.github.io/picard/explain-flags.html>

Decoding SAM flags

This utility makes it easy to identify what are the properties of a read based on its SAM flag value, or conversely, to find what the SAM Flag value would be for a given combination of properties.

To decode a given SAM flag value, just enter the number in the field below. The encoded properties will be listed under Summary below, to the right.

SAM Flag:

Toggle first in pair/ second in pair

Find SAM flag by property:

To find out what the SAM flag value would be for a given combination of properties, tick the boxes for those that you'd like to include. The flag value will be shown in the SAM Flag field above.

1	<input checked="" type="checkbox"/>	read paired
2	<input checked="" type="checkbox"/>	read mapped in proper pair
4	<input type="checkbox"/>	read unmapped
8	<input type="checkbox"/>	mate unmapped
16	<input type="checkbox"/>	read reverse strand
32	<input checked="" type="checkbox"/>	mate reverse strand
64	<input checked="" type="checkbox"/>	first in pair
128	<input type="checkbox"/>	second in pair
256	<input type="checkbox"/>	not primary alignment
512	<input type="checkbox"/>	read fails platform/vendor quality checks
1024	<input type="checkbox"/>	read is PCR or optical duplicate
2048	<input type="checkbox"/>	supplementary alignment

Summary:

- read paired
- read mapped in proper pair
- mate reverse strand
- first in pair

SAM Flag is the sum of Bits

$$99 = 64 + 32 + 2 + 1$$



Sam Flags and Bits

- Flags describe alignments (the flag value is the sum of bits)

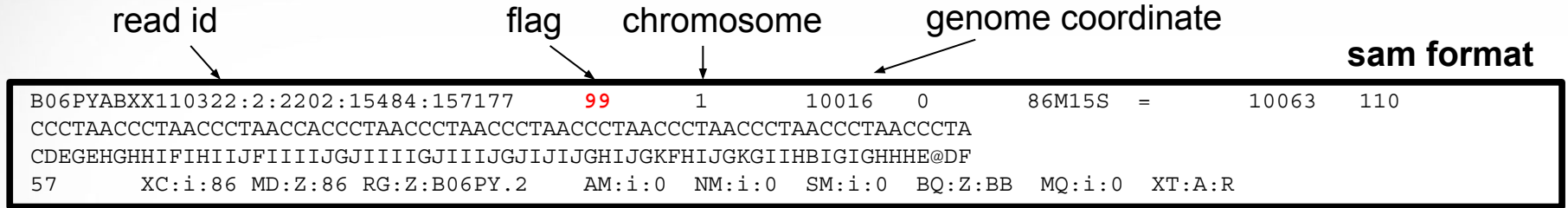

bits: 1 2 4 8 16 32 64 128 256 512 1024 2048

$$1 + 2 + 32 + 64 = 99$$

- Filter bam alignments based on bit in flag (-f and/or -F)

- Keep only reads that are 'mapped in proper pair'

```
samtools view -h -b -f 2 dr34.bam > dr34_paired_reads.bam
```

- Keep all except reads that are 'PCR or optical duplicate'

```
samtools view -h -b -F 1024 dr34.bam > dr34_dedup_reads.bam
```



SAMtools without a Reference Genome

Reference genome represented on top as NNNNNNNNNN

```
samtools tvview dr34.bam
```

```

1      11      21      31      41      51      61      71      81      91      101      111      121      131
NNNNNNNNNNNNNNNNNNNNNNNNNNNNNNNNNNNNNNNNNNNNNNNNNNNNNNNNNNNNNNNNNNNNNNNNNNNNNNNNNNNNNNNNNNNNNNNNNNNN
GACAAAAGAGATGTTTATTITTAATTCAGAGAAAGAAATCAATTTGTTTATTGTTAAGATCACAGACAGAAATCTGTTTGTITGTTTAGTCGCAAAAAGAAATCAGCTACAATACAGTAGAGATACAGTATA
GACAAAAGAGATGTTTATTITTAATTCAGAGAAAGAAATCAATTTGTTTATTGTTAAGATCACAGACAGAAATCTGTTTGTITGTTTAGTCGCAAAAAGAAATCAAGTACAATACAGTAGAGATACAGTATA
GACAAAAGAGATGTTTATTITTAATTCAGAGAAAGAAATCAATTTGTTTATTGTTAAGATCACAGACAGAAATCTGTTTGTITGTTTAGTCGCAAAAAGAAATCAAGTACAATACAGTAGAGATACAGTATA
AATCAGTTGTTTATTGTTAAGATCACAGACAGAAATCTGTTTGTITGTTTAGTCGCAAAAAGAAATCAGCTACAATACAGTACAATACAGTAGAGATACAGTATA
GCTACAATACAGTACAATACAGTAGAGATACAGTATA
GCTACAATACAGTACAATACAGTAGAGATACAGTATA
GCTACAATACAGTACAATACAGTAGAGATACAGTATA

```



SAMtools with a Reference Genome

Reference genome sequence displayed on top

```
samtools tview dr34.bam c_dublinsiensis.fa
```

```
1 11 21 31 41 51 61 71 81 91 101 111 121 131  
GATCAAGTTGAGAGACAAATAGAGTTGTTTATTTAATTACAGAGAAGAATCAGTTGTTTCATTGTTAAGATCACAGACAGAATTCTGTTGTTTGTAGTCGCAAAGAATCAGCTACAATACAGTTAGAGATACAGTATA
```



View at a Specific Coordinate

```
samtools tview dr34.bam c_dublinsiensis.fa -p 1:315398
```

```
315401 315411 315421 315431 315441 315451 315461 315471 315481 315491 315501 315511 315521  
CGATGTCAAGATAAACAATAGTCATGTTTCTGATGGGTCTAATTTTACGATTCACAATCATCGGATGATGAAATTACTGGAAATCAGGGTGATGCCAGTGGTGTAGGTGGTAGAAAATCACCTAATTATATCAAGAATG  
A.....  
a.....,a,,a,,,,,,a,,,,,,a,,,,,,a,,,,,,a,,,,,  
a.....  
A.....  
a.....
```



Sequence Error Correction In Short Reads



Sequencing Errors in Short Reads

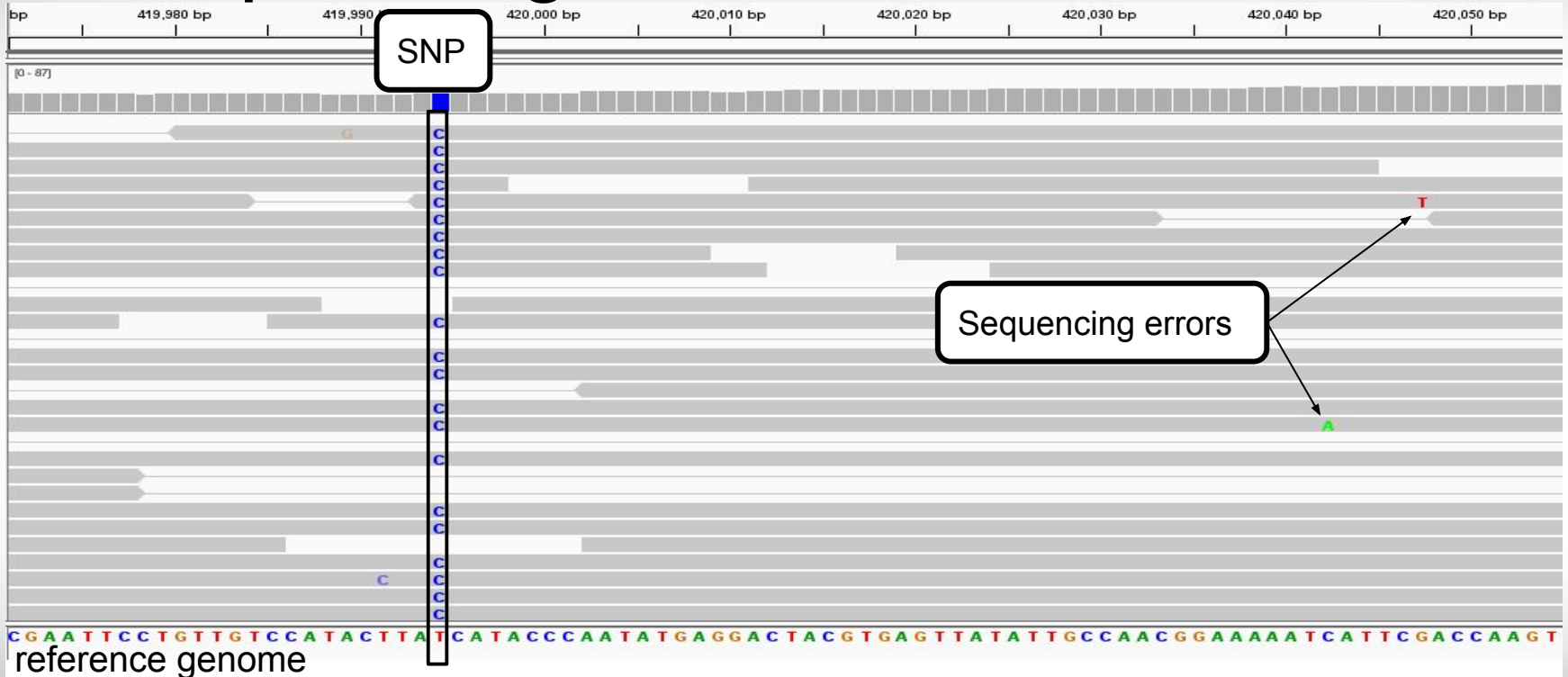

Tool for correcting sequencing errors:

`module spider` Lighter



Digital Normalization



Digital Normalization

Reduce memory requirements by reducing the number of redundant sequence reads if you have a very high sequencing coverage (> 200x)

`module spider BMap`

Use the `bbnorm.sh` script in the BMap module

A Reference-Free Algorithm for Computational Normalization of Shotgun Sequencing Data

C. Titus Brown^{1,2,*}, Adina Howe², Qingpeng Zhang¹, Alexis B. Pyrkosz³, Timothy H. Brom¹

¹ Computer Science and Engineering, Michigan State University, East Lansing, MI, USA

² Microbiology and Molecular Genetics, Michigan State University, East Lansing, MI, USA

³ USDA Avian Disease and Oncology Laboratory, East Lansing, MI, USA

* E-mail: ctb@msu.edu



Sequence Variant Calling



Sequence Variant Calling

- Start with aligning reads to a reference
 - GATK does not require QC trimming
 - Mark PCR duplicates with Picard
- Differentiate between sequencing errors and SNPs
 - Calling SNPs may require a min read depth of 10x (higher for indels)
 - Calling variants may require 1/3 of reads to contain SNP
 - Strand bias may result as a consequence of the sequencing chemistry's response to certain DNA sequence motifs but it can be detected computationally
- BLAST reads with SNPs to identify variant calls due to misalignments especially with duplicated genes
- Variant Call Format (vcf) – standard format of variant calls
- Identify multiple-nucleotide polymorphism (MNP)
 - Two SNPs within a single codon

	codon	translation
Reference:	TTT	Phe
SNP 1:	TTA	Leu
SNP 2:	TAT	Tyr
SNP 1 + 2:	TAA	STOP



Marking PCR Duplicates

- PCR duplicates are artifacts resulting from a PCR amplification step during NGS library preparations.
- PCR duplicates should be removed/marked as to not bias the frequency of variants or gene expression levels
 - Use picard tools to mark duplicates
 - Freebayes will ignore marked duplicates during variant calling

```
module spider picard
```

Variant Calling Tools

Use bam file of sequence reads aligned to a reference as input for the following four work flows

1. GATK `module spider GATK picard SAMtools`
 - No need to QC trim reads, the GATK best practices pipeline will perform the necessary steps including marking PCR duplicates
 - You need a set of known variants for your species (dbSNP) or you can bootstrap your population to get variant frequency
 - Used in conjunction with other tools
 - samtools
 - picard
2. SAMtools and BCFtools `module spider SAMtools BCFtools`
3. VarScan `module spider VarScan`
4. FreeBayes `module spider FreeBayes`



Sample vcf File Format

```
##fileformat=VCFv4.0
##fileDate=20110705
##reference=1000GenomesPilot-NCBI37
##phasing=partial
##INFO=<ID=NS,Number=1,Type=Integer,Description="Number of Samples With Data">
##INFO=<ID=DP,Number=1,Type=Integer,Description="Total Depth">
##INFO=<ID=AF,Number=.,Type=Float,Description="Allele Frequency">
##INFO=<ID=AA,Number=1,Type=String,Description="Ancestral Allele">
##INFO=<ID=DB,Number=0,Type=Flag,Description="dbSNP membership, build 129">
##INFO=<ID=H2,Number=0,Type=Flag,Description="HapMap2 membership">
##FILTER=<ID=q10,Description="Quality below 10">
##FILTER=<ID=s50,Description="Less than 50% of samples have data">
##FORMAT=<ID=GQ,Number=1,Type=Integer,Description="Genotype Quality">
##FORMAT=<ID=GT,Number=1,Type=String,Description="Genotype">
##FORMAT=<ID=DP,Number=1,Type=Integer,Description="Read Depth">
##FORMAT=<ID=HQ,Number=2,Type=Integer,Description="Haplotype Quality">
#CHROM POS ID REF ALT QUAL FILTER INFO FORMAT Sample1 Sample2
2 4370 rs6057 G A 29 . NS=2;DP=13;AF=0.5;DB;H2 GT:GQ:DP:HQ 0|0:48:1:52,51 1|0:48:8:51,51
2 7330 . T A 3 q10 NS=5;DP=12;AF=0.017 GT:GQ:DP:HQ 0|0:46:3:58,50 0|1:3:5:65,3
2 110696 rs6055 A G,T 67 PASS NS=2;DP=10;AF=0.333,0.667;AA=T;DB GT:GQ:DP:HQ 1|2:21:6:23,27 2|1:2:0:18,2
2 130237 . T . 47 . NS=2;DP=16;AA=T GT:GQ:DP:HQ 0|0:54:7:56,60 0|0:48:4:56,51
2 134567 microsat1 GTCT G,GTACT 50 PASS NS=2;DP=9;AA=G GT:GQ:DP 0/1:35:4 0/2:17:2
```

3 more columns not shown due to width of rows



vcf File Column Descriptions

```
##fileformat=VCFv4.0
##fileDate=20110705
##reference=1000GenomesPilot-NCBI37
##phasing=partial
##INFO=<ID=NS,Number=1,Type=Integer,Description="Number of Samples With Data">
##INFO=<ID=DP,Number=1,Type=Integer,Description="Total Depth">
##INFO=<ID=AF,Number=.,Type=Float,Description="Allele Frequency">
##INFO=<ID=AA,Number=1,Type=String,Description="Ancestral Allele">
##INFO=<ID=DB,Number=0,Type=Flag,Description="dbSNP membership, build 129">
##INFO=<ID=H2,Number=0,Type=Flag,Description="HapMap2 membership">
##FILTER=<ID=q10,Description="Quality below 10">
##FILTER=<ID=s50,Description="Less than 50% of samples have data">
##FORMAT=<ID=GQ,Number=1,Type=Integer,Description="Genotype Quality">
##FORMAT=<ID=GT,Number=1,Type=String,Description="Genotype">
##FORMAT=<ID=DP,Number=1,Type=Integer,Description="Read Depth">
##FORMAT=<ID=HQ,Number=2,Type=Integer,Description="Haplotype Quality">
#CHROM POS ID REF ALT QUAL FILTER INFO
2 4370 rs6057 G A 29 . NS=2;DP=13;AF=0.5;DB;H2
2 7330 . T A 3 q10 NS=5;DP=12;AF=0.017
2 110696 rs6055 A G,T 67 PASS NS=2;DP=10;AF=0.333,0.667;AA=T;DB
2 130237 . T . 47 . NS=2;DP=16;AA=T
2 134567 microsat1 GTCT G,GTACT 50 PASS NS=2;DP=9;AA=G
```

variants that are phased are inherited together

| indicates phased variants
/ indicates non-phased variants

FORMAT	Sample1	Sample2
GT:GQ:DP:HQ	0 0:48:1:52,51	1 0:48:8:51,51
GT:GQ:DP:HQ	0 0:46:3:58,50	0 1:3:5:65,3
GT:GQ:DP:HQ	1 2:21:6:23,27	2 1:2:0:18,2
GT:GQ:DP:HQ	0 0:54:7:56,60	0 0:48:4:56,51
GT:GQ:DP	0/1:35:4	0/2:17:2

Sample1 haplotypes: GTGT and GTTT

Sample2 haplotypes: ATTT and GAGT

<https://www.broadinstitute.org/gatk/guide/tagged?tag=phasing>



Summarizing Variant Calls from Different Tools

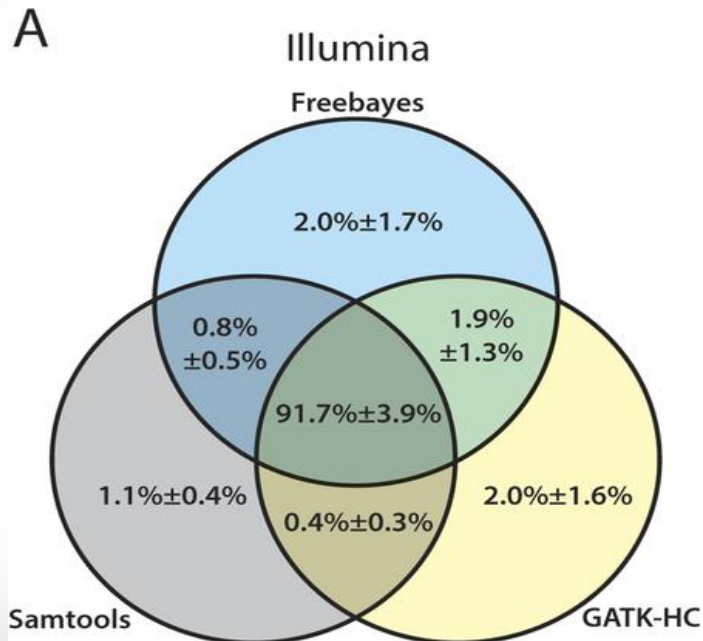

The mean percentage with standard deviation of confidence variant calls with equal to or higher than the quality score threshold of 20 are represented for (A) Illumina data sets

Huang et al 2015 doi:10.1038/srep17875

Consequence of Amino Acid Change

- Assess consequence of amino acid change based on sequence conservation across multiple species using the PROVEAN tool
- Variants with a score equal to or below -2.5 are considered “deleterious”

`module spider PROVEAN`

```
## PROVEAN v1.1 output ##
# Query sequence file:  CTRG_00013.fa
# Variation file:      CTRG_00013.var
# Protein database:   /scratch/datasets/blast/nr
[16:01:13] searching related sequences...
[16:16:36] clustering subject sequences...
# Number of clusters:    30
# Number of supporting sequences used: 245
[16:18:39] computing delta alignment scores...
## PROVEAN scores ##
# VARIATION SCORE
A431S   -0.455
E411K   -3.051
E226Q   -1.564
```

Verify that enough supporting sequences were found

“deleterious”

Annotate Variants

module spider snpEff

- A file of variant calls in vcf format is needed
- A reference sequence with gene annotations is needed
- snpEff annotates a vcf file
 - There are > 2,500 pre-built databases available and you can build your own if needed
 - Annotates MNP (multiple nucleotide polymorphism)
 - Codon change due to two SNPs: ACA → GGA

```
5          325795      .          AC          GG          23.8901      .
AB=0.428571;ABP=3.32051;AC=1;AF=0.5;AN=2;AO=3;CIGAR=2X;DP=7;DPB=7;DPRA=0;EPP=3.73412;
EPPR=3.0103;GTI=0;LEN=2;MEANALT=1;MQM=33;MQMR=48.5;NS=1;NUMALT=1;ODDS=5.49681;PAIRED=0;
PAIREDR=0.5;PAO=0;PQA=0;PQR=0;PRO=0;QA=114;QR=150;RO=4;RPL=3;RPP=9.52472;RPPR=3.0103;
RPR=0;RUN=1;SAF=2;SAP=3.73412;SAR=1;SRF=2;SRP=3.0103;SRR=2;TYPE=mnnp;technology.ILLUMINA=1;
ANN=GG|missense_variant|MODERATE|CD36_51230|CD36_51230|transcript|CAX41505.1|
protein_coding|1/1|c.1657_1658delACinsGG|p.Thr553Gly|1657/1851|1657/1851|553/616||
GT:DP:RO:QR:AO:QA:GL          0/1:7:4:150:3:114:-6.7054,0,-11.1847
```

Viewing SNPs in a Diploid Organism

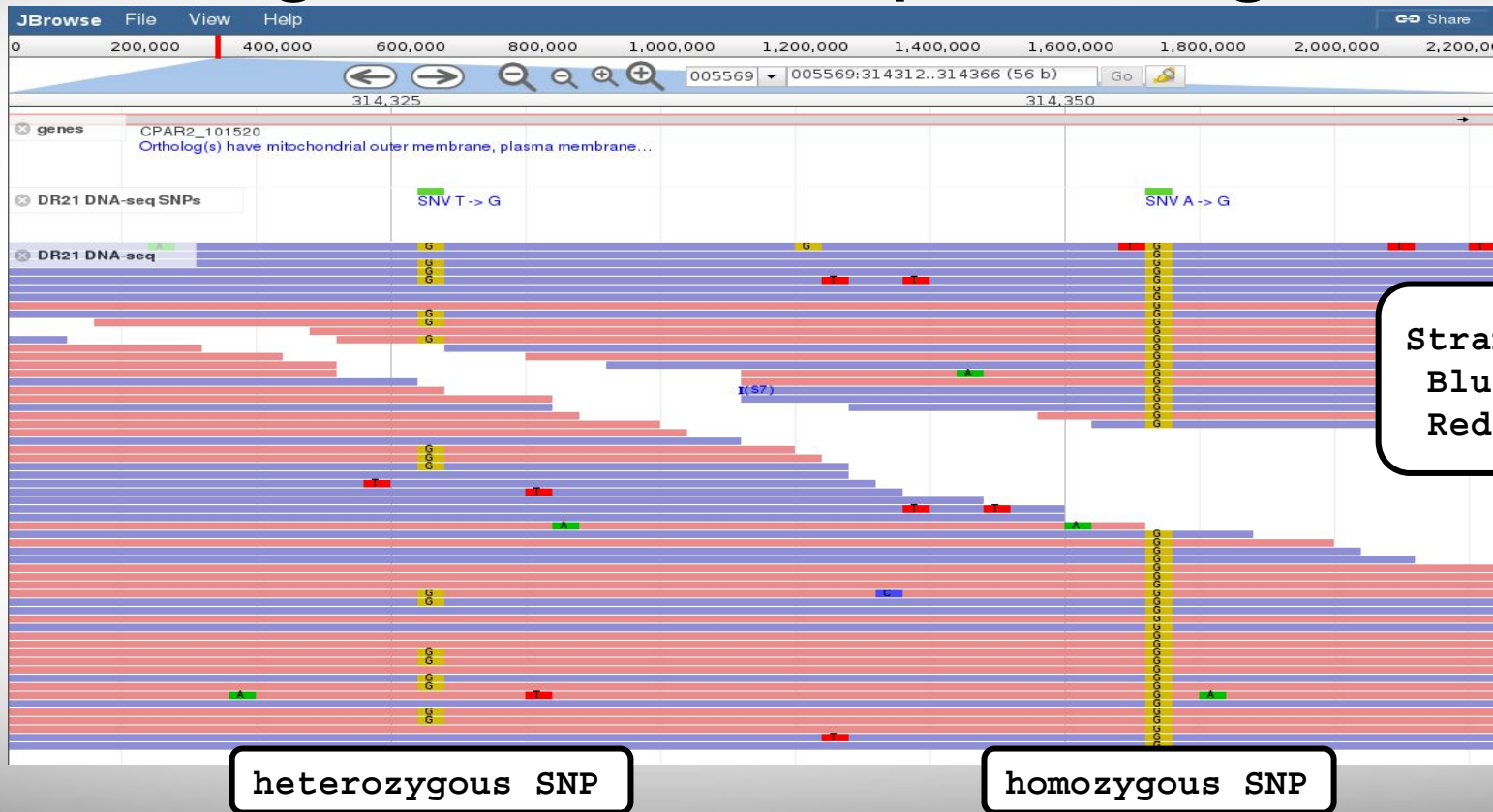

Strand:
Blue = +
Red = -

heterozygous SNP

homozygous SNP



Example of Sequencing Strand Bias



RNA-seq Overview



RNA-seq Applications

- Differential Expression (DE) and transcript abundance
 - HISAT2, Bowtie, TopHat, Cufflinks, Cuffmerge, Cuffdiff
 - DESeq and DESeq2 (R package)
 - EdgeR (R package)
- Transcriptome assembly (find isoforms and rare transcripts)
 - *de novo* (Trinity, Oases, SOAPdenovo-Trans)
 - reference based (Trinity, StringTie)
- Genome Annotation
 - Align to assembly for validation of gene models
- Variant Calling
 - STAR/Picard/GATK (Haplotype Caller (HC) in RNA-seq mode)
- *de novo* genome assembly scaffolding
 - L_RNA_scaffolder
- Identify fusion transcripts
 - tophat-fusion

Sequence Depth for RNA-seq Differential Expression

RNA-seq differential expression studies: more sequence or more replication?

Liu, Yuwen, Zhou, Jie and White, Kevin P. [Bioinformatics](#). 2014 Feb 1; 30(3): 301–304.
doi: [10.1093/bioinformatics/btt688](https://doi.org/10.1093/bioinformatics/btt688) PMID: PMC3904521

- Using more biological replicates instead of increasing sequencing depth resulted in improved accuracy of expression estimation
- Use more biological replicates at lower sequencing depth is more beneficial than fewer samples at a higher sequencing depth
- Increasing sequence depth is beneficial for exon or transcript-specific expression studies

RNA-seq Transcriptome Assembly

- Assembly with a reference genome

```
module spider Trinity
```

```
module spider HISAT2 Cufflinks
```

```
module spider Scripture
```

```
module spider StringTie
```

- *de novo* assembly without a reference genome

```
module spider Trinity
```

```
module spider Oases
```

Digital Normalization for Transcriptome Assembly

- Reduce memory requirements by reducing the number of redundant sequence reads if you have a very high sequencing coverage ($> 200x$)
- Trinity 2.4.0 automatically normalizes reads to a depth of 50
- The `bbnorm.sh` script in BBMap can normalize reads

```
module spider BBMap
```

Trinity – How it works:

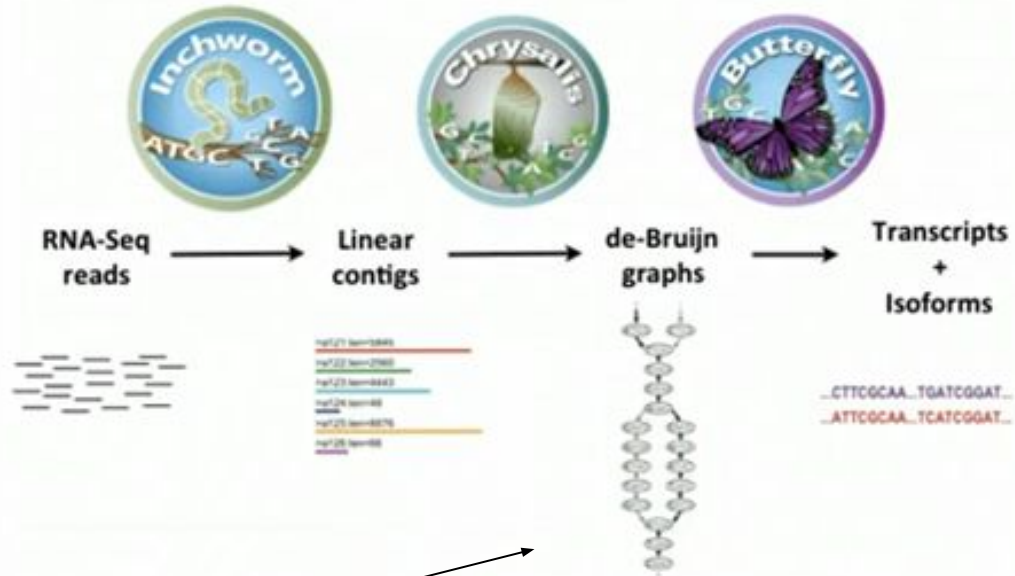

Thousands of disjoint graphs

ideally one graph per gene/transcript

Broad Institute

<http://www.rna-seqblog.com/a-collection-of-new-rna-seq-videos-from-the-broad-institute/>

Running Trinity on Ada

- Trinity uses 100,000s of intermediate files
 - Contact **help@hprc.tamu.edu** and request a file quota increase before running Trinity
 - Run one Trinity job at a time and check resource usage
 - `showquota`
 - It is recommended not to run multiple Trinity jobs unless you know memory usage and an estimate of the number of temporary files
 - Trinity creates checkpoints and can be restarted if it stops due to file/disk quota met, out of memory or runtime
 - Checkpoints are not available when running Trinity in Galaxy
 - Checkpoints are not available if you use \$TMPDIR with Trinity
 - need to rsync results from \$TMPDIR at end of job script
 - checkpoints are stored in \$TMPDIR which is deleted after job ends
- See GCATemplates for sample Trinity scripts



ChIP-seq



Chromatin immunoprecipitation (ChIP) is a technique for identifying and characterizing elements in protein-DNA interactions involved in gene regulation or chromatin organization.

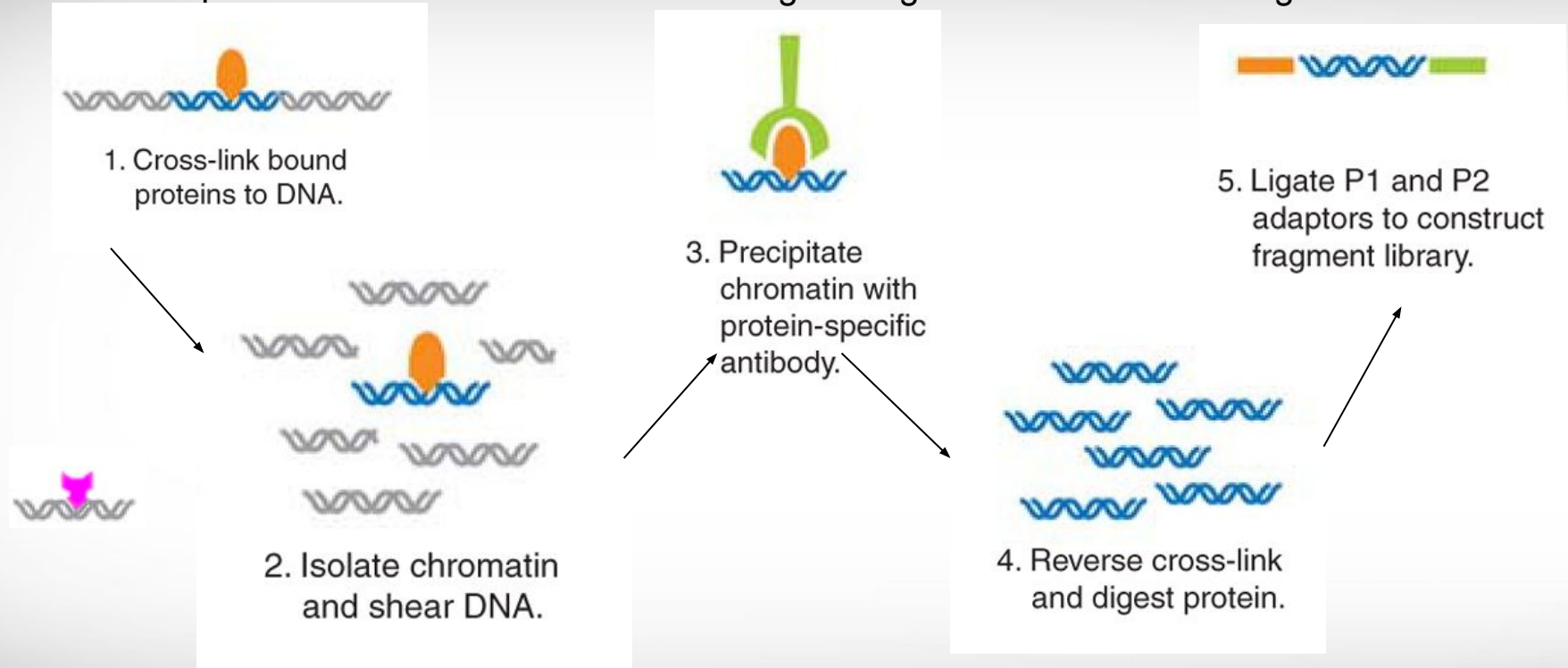

Chromatin immunoprecipitation sequencing (ChIP-Seq) on the SOLiD™ system
Nature Methods 6, (2009)

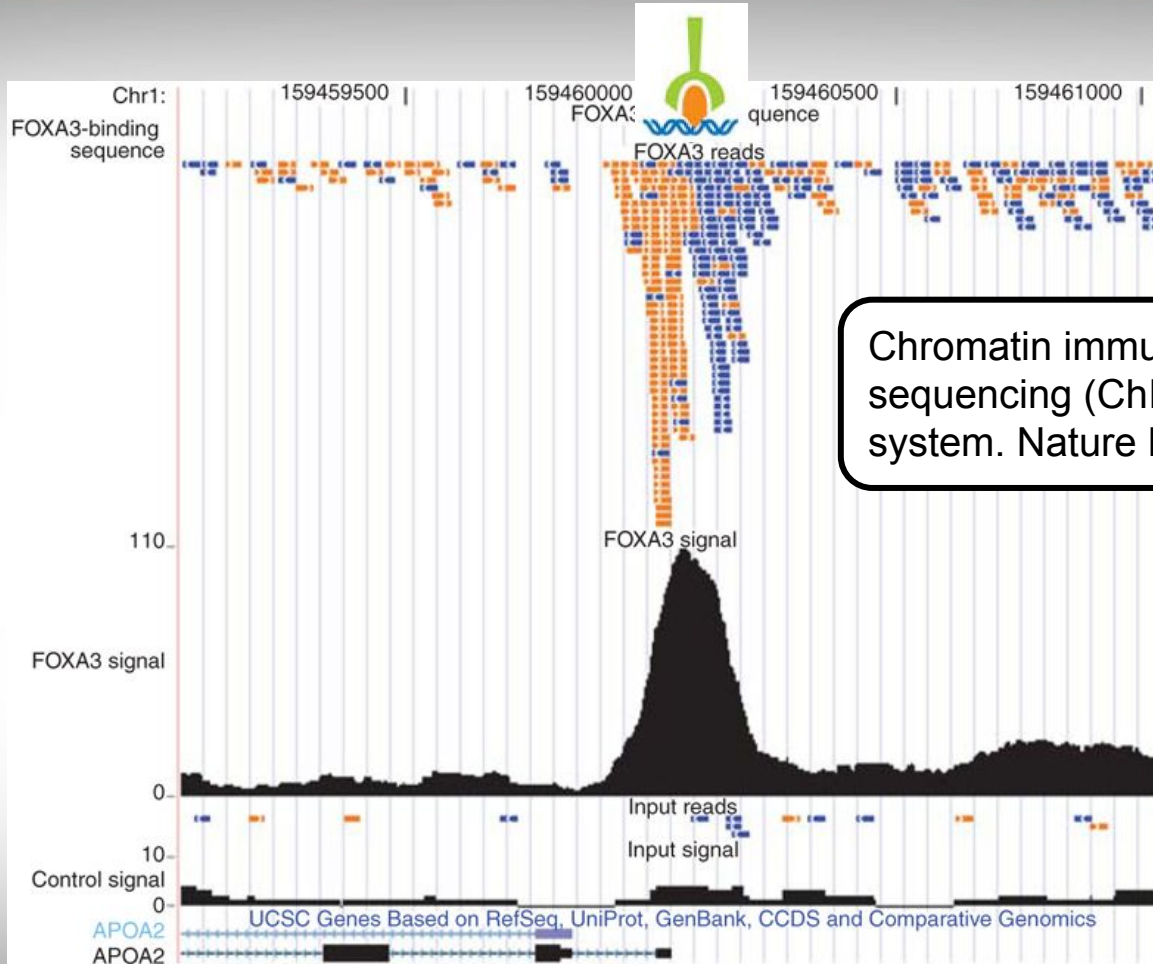

Chromatin immunoprecipitation sequencing (ChIP-Seq) on the SOLiD™ system. Nature Methods 6, (2009)



The goal is to find a consensus DNA sequence among the sequences at each peak which will give us the DNA sequence motif that a protein recognizes and binds

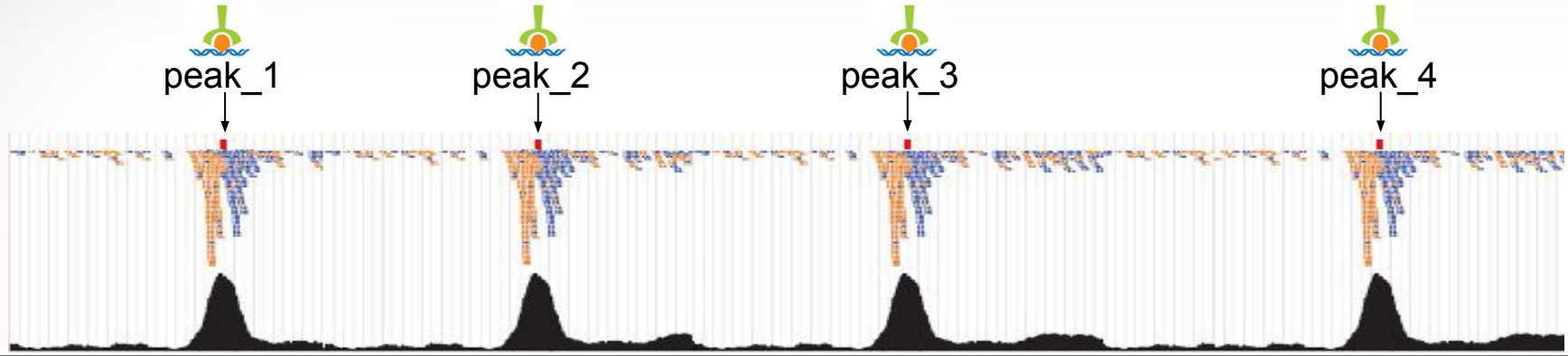

A sequence logo can be used to represent the DNA sequence motif where the protein binds

Generate a sequence logo with the R package seqLogo

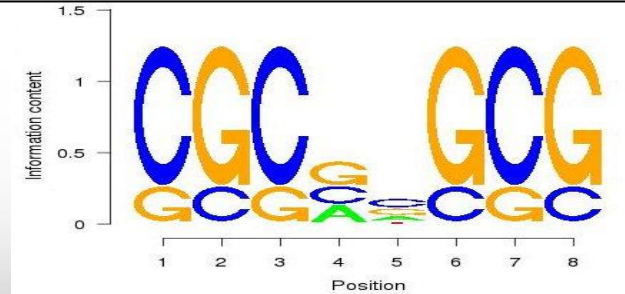

```
module load R_tamu/3.3.1-intel-2015B-default-mt
```

ChIP-seq Tools

- Protein-DNA interactions
 - `module spider MACS`
 - `module spider MACS2`
- Subdivision of ChIP-seq regions into discrete signal peaks
 - `module spider PeakSplitter`
- Peak caller
 - `module spider PeakRanger`
 - `module spider BroadPeak`
- Identify enriched domains from histone modification ChIP-seq data
 - `module spider SICER`

HPRC Resources

- Free Help
 - Send an email to help@hprc.tamu.edu if you have any questions regarding Bioinformatics tools usage on HPRC clusters
 - First spend some time investigating the error
 - read log files, stdout file, stderr file, tool manual
 - Google search
 - Google user groups: many are tool specific
 - Include details about your issue
 - Which cluster or which Galaxy you are using
 - Which tool you are using
 - Which modules you have loaded
 - Commands you used in your job script
 - Error messages you are seeing
- HPRC NGS data analysis tools Documentation
 - <https://hprc.tamu.edu/wiki/index.php/Ada:Bioinformatics>





**HIGH PERFORMANCE
RESEARCH COMPUTING**
TEXAS A&M UNIVERSITY

Thank you.

Any question?

