

Introduction to NGS Data Analysis on the HPRC Clusters

Fall 2022

Your Login Password

- Both state of Texas law and TAMU regulations prohibit the sharing and/or illegal use of computer passwords and accounts
- Don't write down passwords
- Don't choose easy to guess passwords
- Change passwords frequently

There will be a 10 minute break halfway through today's short course

Introduction to NGS

- NGS Sequencing Technology
- NGS Tools on Grace
- Quality Control (QC)
- Template Job Scripts
- Visualize BAM Alignment Files
- Sequence Variant Calling
- RNA-seq Overview
- CHIP-seq
- Biocontainers

Options for Running Bioinformatics Tools

HPRC Portal

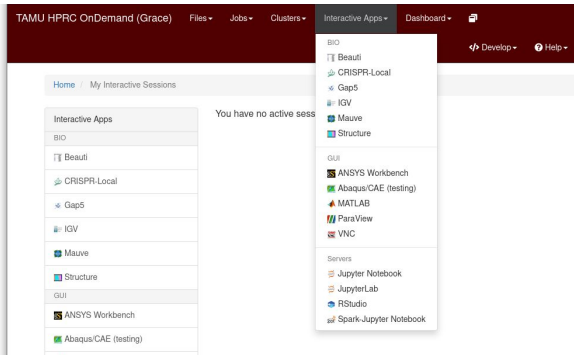

- Access is web browser based
- All HPRC software tools are available either as a GUI or via Unix command line
- Can access Unix command line
 - Grace or Terra
- Best for GUI apps
 - RStudio
 - IGV

Unix command line

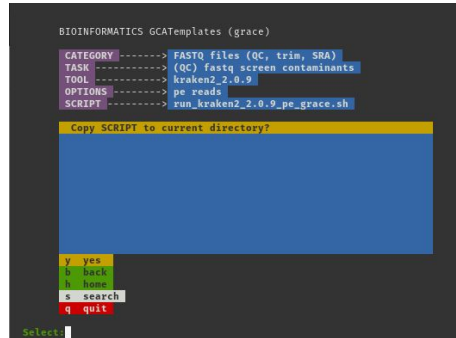

- Need to learn Unix and Slurm
- Bioinformatics template scripts available
- GUI software is not very responsive interactively
- Need SSH client on your Windows computer such as MobaXterm or use HPRC portal

HPRC Maroon Galaxy

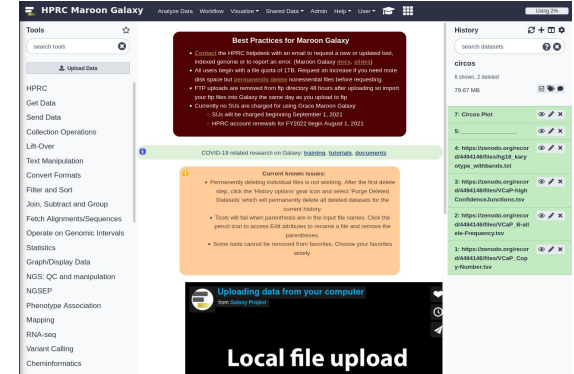

- Access is web browser based
- First [apply](#) for an HPRC account then request a Galaxy account
- Can request HPRC to add tools from the [usegalaxy.org](#) [toolshed](#) or create a custom tool

Using SSH - MobaXterm (on Windows) to Connect to Grace

click Session to begin

- X11 is enabled by default in MobaXterm
- Use "ssh -X" when using the terminal to enable X11

X11 enables you to view images when using the terminal

<https://hprc.tamu.edu/wiki/HPRC:MobaXterm>

Connect using the HPRC portal

portal-grace.hprc.tamu.edu

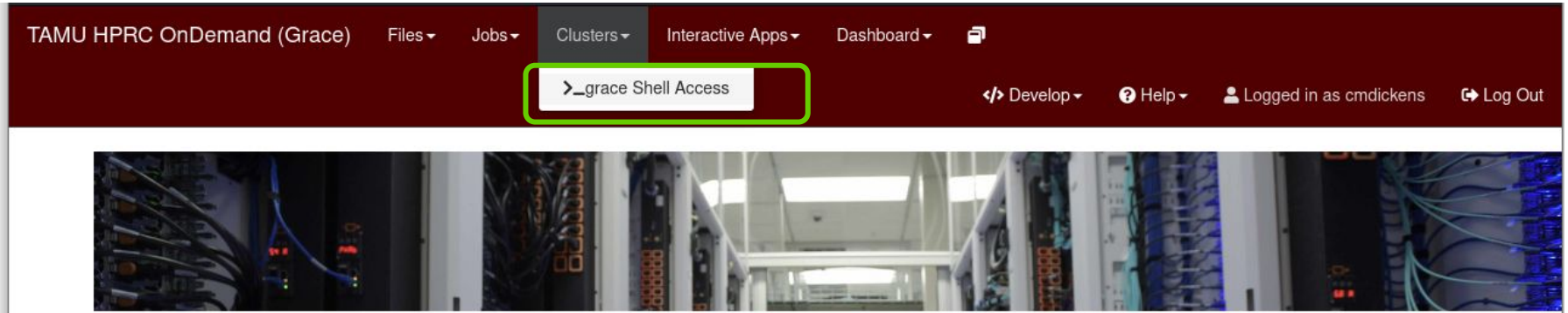

There are no SUs charged for using the Shell Access

HPC Diagram

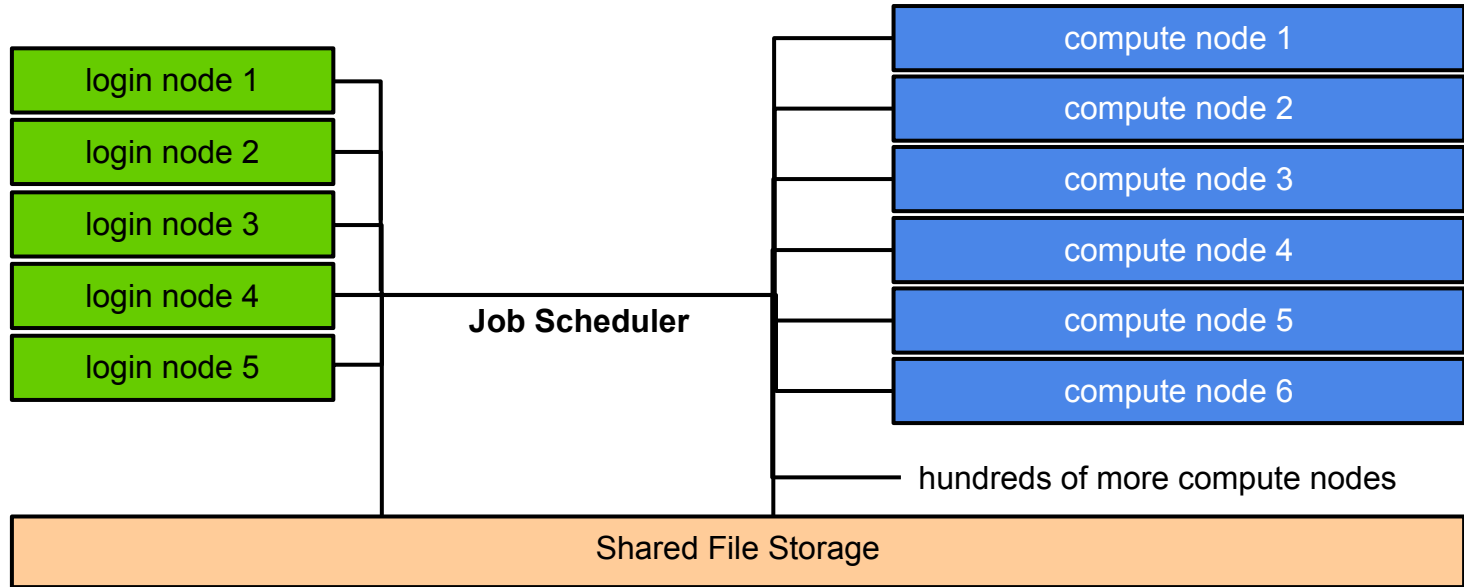

login nodes are for:

- file manipulation and job script preparation
- software installation and testing
- short computational jobs (< 60 minutes and max 8 cores)
also be aware of amount of memory utilized

compute nodes are for:

- computational jobs which can use up to 48 cores and/or up to 360GB memory (3TB for bigmem nodes) per compute node
computational jobs running > 60 minutes

Next Generation Sequencing (NGS)

Illumina Sequencing Technology



iSeq 100



MiniSeq



MiSeq Series +



NextSeq 550 Series +



NextSeq 2000



NovaSeq 6000

<http://www.illumina.com/systems/sequencing-platforms.html>

Illumina Sequencing Libraries

illumina.com

single end

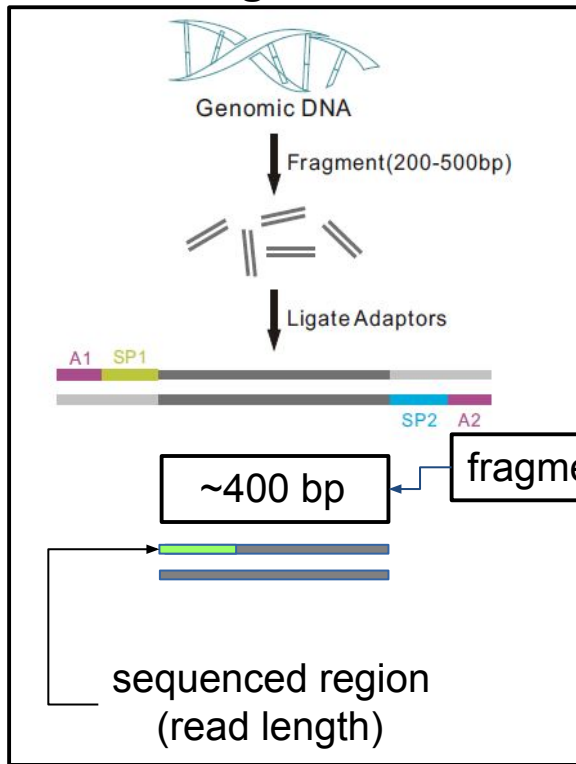

paired ends

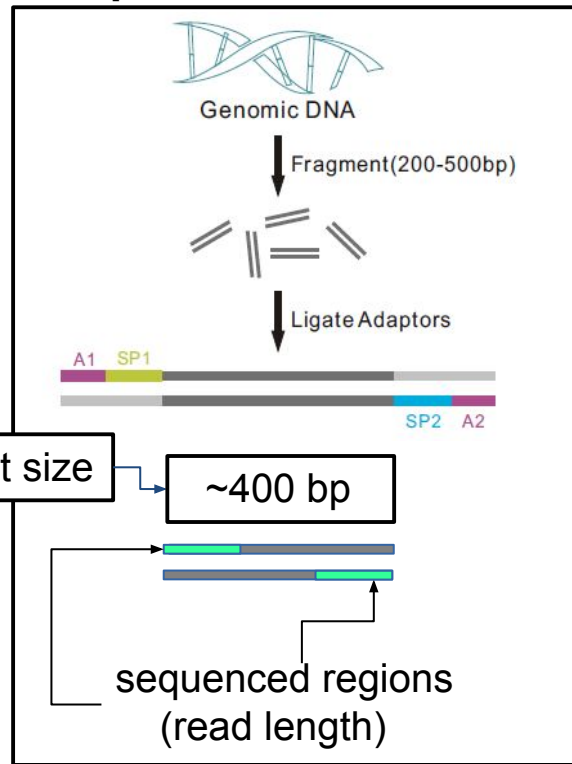

mate pairs

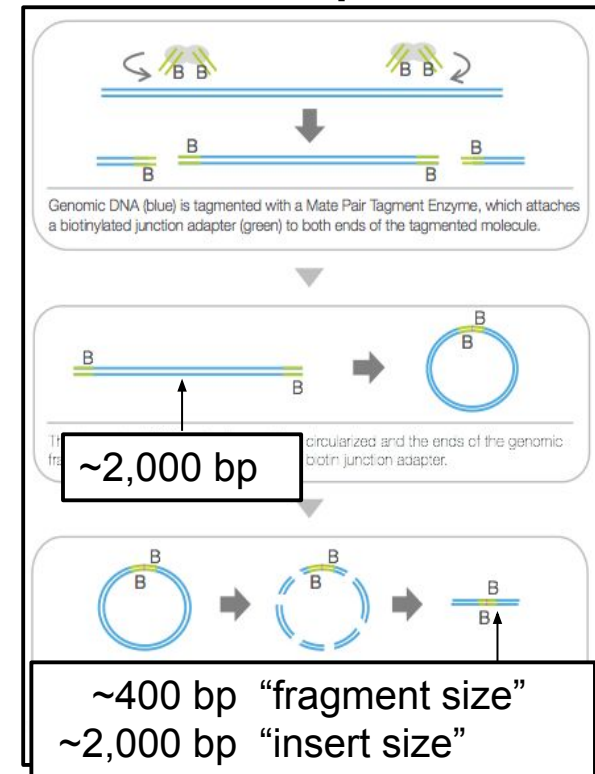

Paired End Reads

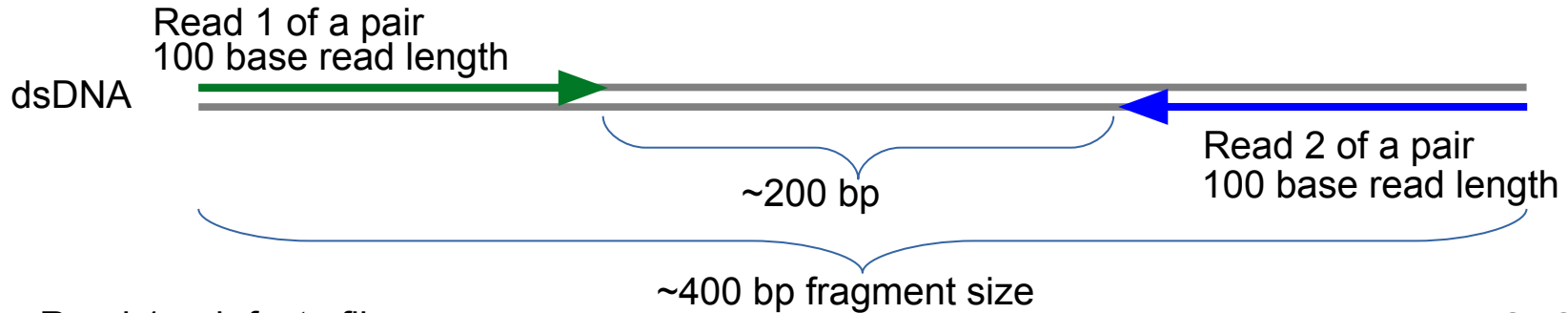

Read 1 pair fastq file

FASTQ format

```
@M00861:1:000000000-A36BE:1:1101:14650:1529 1:N:0:8
TTCTTAAAAATACCATAAAAAGGCTTAAACTTGCCATTTACGACGGATTAAATTCCAACTCTTTTCGGCTATCTTCATCTTTTAAGGTAAATGACTCATAACGG
+
FFFHBBFFHHIIIIIIHFHHCGEFGHHIHHHIHD/?DGGHHH@DEB,5EGHGHIIHIF?FGHHCCBFDGHFHDGHGFFFFGDFHH?DFHDFHHHFHFHFHHH
```

Read 2 pair fastq file

```
@M00861:1:000000000-A36BE:1:1101:14650:1529 2:N:0:8
ACTAAAAATCAATTTTATCAATTTCAAGCTCTACCTTATTTACTCATTTATTTTAGTGATGGCCACTTTAATAAAAAATATTGGTAGCATATTTTGCAATAGCGG
+
BFFHIIHHHFHHDGHIHHIHHHGGHHHHHFFHDFHIIHIIHIDFHIIHIIH=AAFHIIHFHGFHHHHHGGHHIHHFGFFFEFGHHHDGHHH/CGHIFHHH
```

Maintain Read Pair Order

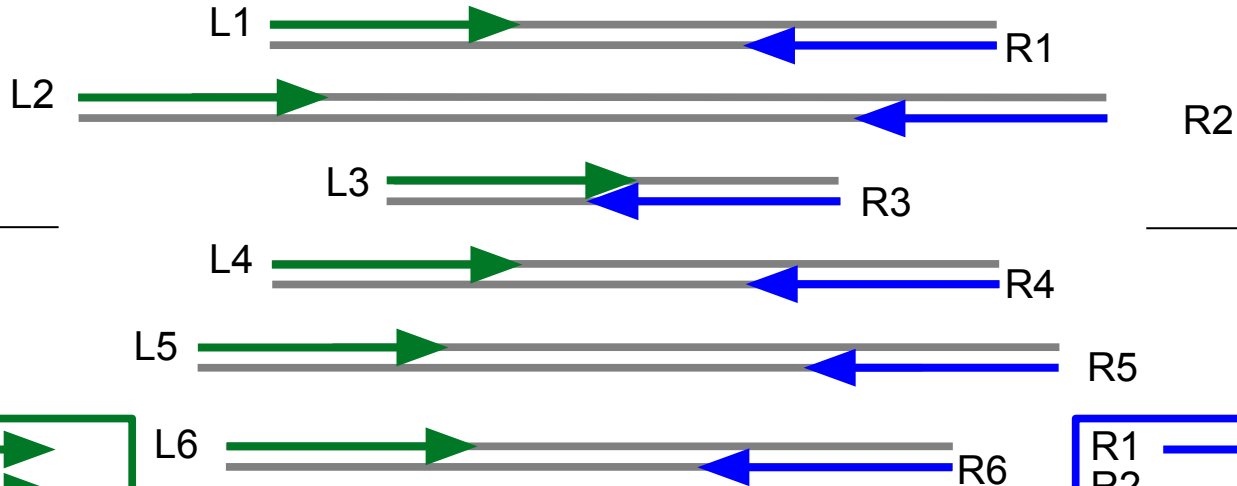

DNA Fragment lengths will be different but
sequence reads may all be the same length

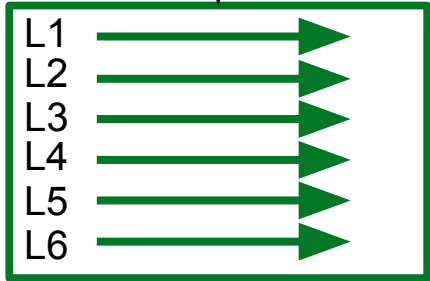

Left Read 1 paired end fastq file

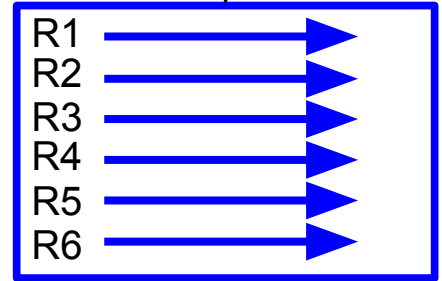

Right Read 2 paired end fastq file

MiSeq Can Perform Initial QC Trimming

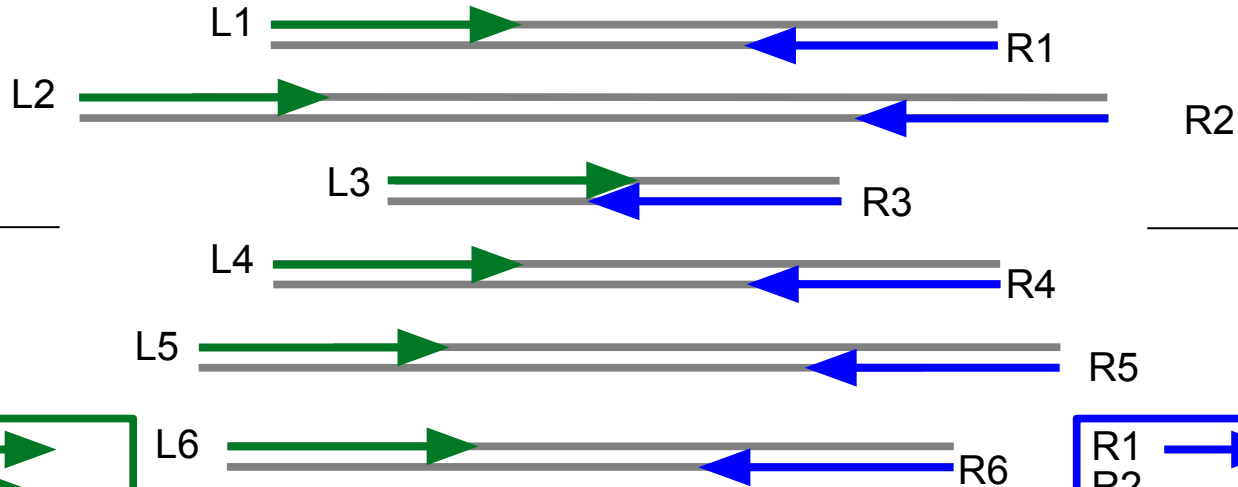

DNA Fragment lengths will be different but
sequence reads can have different lengths

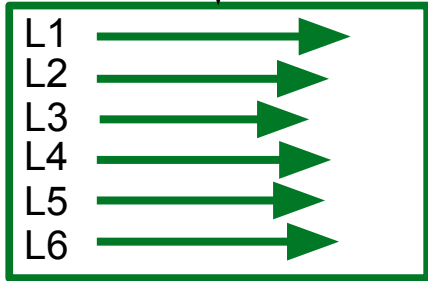

Left Read 1 paired end fastq file

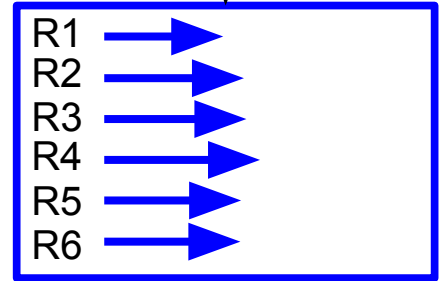

Right Read 2 paired end fastq file

Oxford Nanopore Long Read Sequencing



Oxford Nanopore Technologies (ONT)

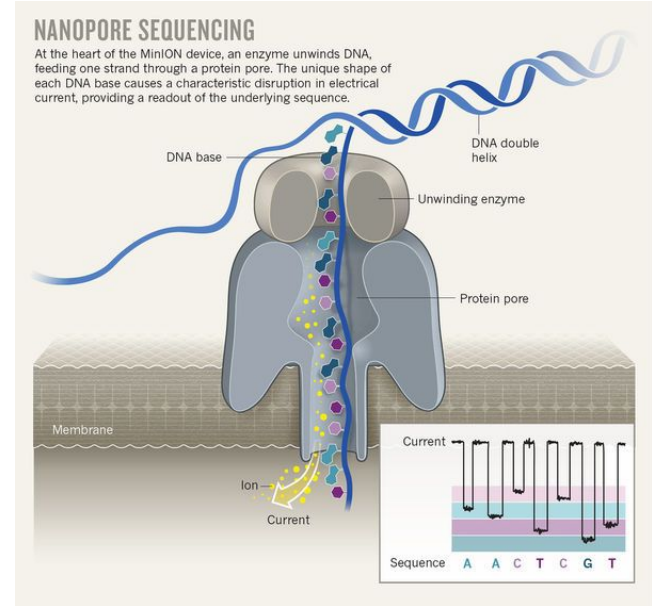

<http://blogs.nature.com>
TechBlog: The nanopore toolbox
16 Oct 2017 | 12:00 GMT | Posted by Jeffrey Perkel

PacBio Long Read Sequencing

Sequel Sequencer

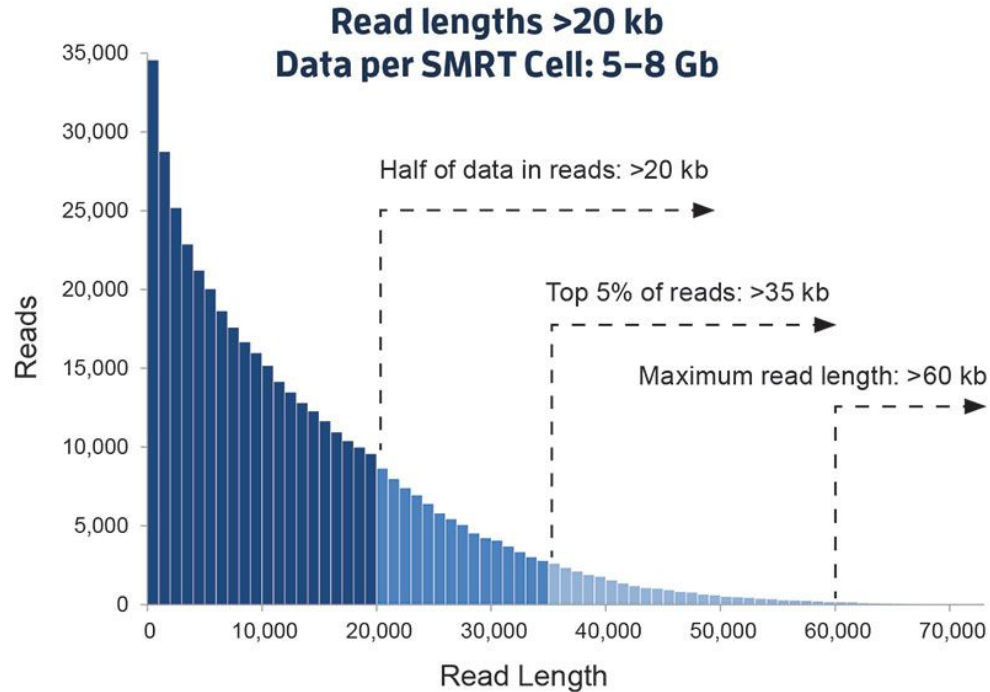

pacb.com

PacBio Long Read Sequencing

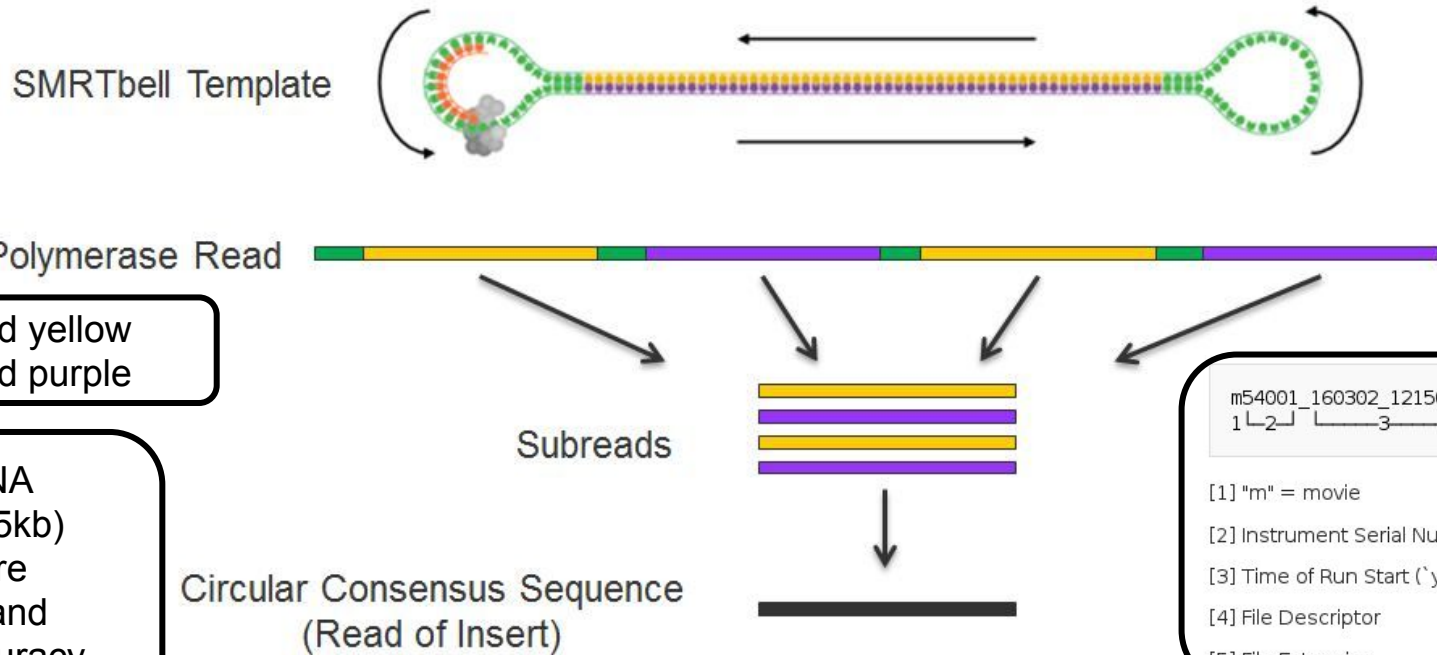

+ Strand yellow
- Strand purple

Shorter DNA fragment (5kb) equals more subreads and higher accuracy than longer (60kb)

```
m54001_160302_121501.subreads.bam  
1 | 2 | 3 | 4 | 5 |  
[1] "m" = movie  
[2] Instrument Serial Number  
[3] Time of Run Start ('yymmdd_hhmmss')  
[4] File Descriptor  
[5] File Extension
```

pacb.com

PacBio HiFi Reads

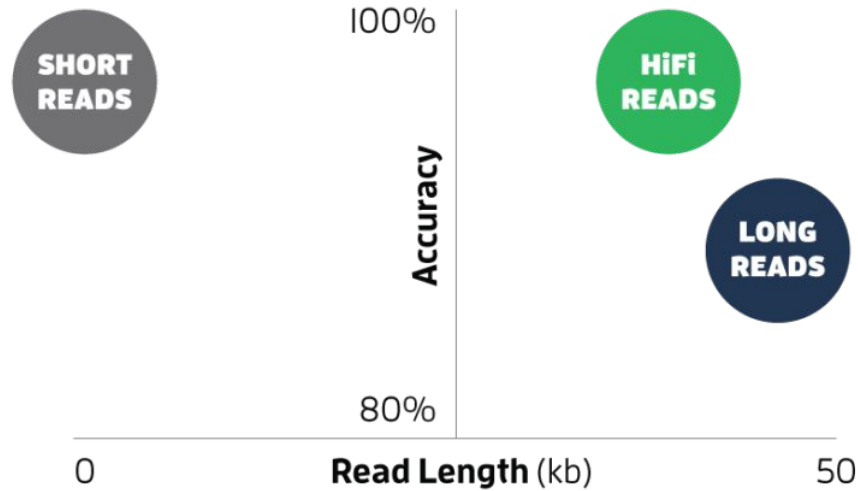

<https://www.pacb.com/blog/hifi-webinar>

- HiFi reads are not subreads since they are already error corrected
- HiFi utilize single-molecule consensus rather than multiple-molecule consensus

PacBio Sequencing Tools

- Sequence Alignments
 - Minimap2
- Genome Assembly
 - Canu: PacBio long read assembler
 - grid mode not supported on HPRC clusters
 - Unicycler: bacterial genomes
 - wtdbg2: 10x faster than Canu
 - assembly is very close but not as complete as Canu
 - Flye: PacBio and ONT reads; metagenome also available
- Improve draft assemblies
 - ArrowGrid_HPRC (Terra)
 - Purge_Haplotigs (Terra)
 - Circlator

https://hprc.tamu.edu/wiki/Bioinformatics:PacBio_tools

Tool Suites

- **SMRT-Link** Grace, Terra (PacBio)
 - contains command line versions of additional SMRT Analysis tools
 - PacBio's open-source SMRT Analysis software suite is designed for use with Single Molecule, Real-Time (SMRT) Sequencing data.

bam2fasta	bam2fastq	bamsieve	bax2bam	blasr	ccs	cleric	cromwell
daligner	daligner_p	datander	dataset	dazcon	DB2Falcon	DB2fasta	DBdump
DBdust	DBrm	DBshow	DBsplit	DBstats	dexta	falconc	falconcpp
fasta2DB	fuse	gcpp	HPC.daligner	HPC.REPmask		HPC.TANmask	
ipdSummary	ipython	ipython2	isoseq3	juliet	julietflow	LA4Falcon	LA4Ice
laa	laagc	LAmerge	LAsort	lima	minimap2	motifMaker	pballign
pbcromwell	pbdagcon	pbindex	pbmm2	pbserve	pbsv	pbvalidate	ra
REPmask	samtools	sawriter	summarizeModifications		TANmask	undexta	womtool

```
module load SMRT-Link/10.1.0.119588-cli-tools-only
```

Genome Hybrid Assemblers (Long-reads + Illumina reads)

- **SPAdes**
 - subreads as input files
 - no need to correct subreads with short reads prior to assembly
 - uses long reads for gap closure and repeat resolution
- **MaSuRCA**
 - All long-reads must be in a single fasta file
- **Unicycler**
 - assembly pipeline for bacterial genomes
 - circularises replicons without the need for a separate tool like Circulator

NGS Tools on Grace

Where to Find NGS Tools

- Search TAMU HPRC Documentation
 - <https://hprc.tamu.edu/wiki/Bioinformatics>
- Type any the following Unix commands to see which tools are already installed on Grace
 - `module spider toolname` (not case sensitive, but read the entire output)
 - `module key assembly` (some modules may be missed because this searches tool descriptions)
- Some tools such as qiime2 are available with Anaconda and do not show up with the module command
- If you are unable to find a tool that you want installed on Grace, send an email with the URL link to: help@hprc.tamu.edu
- Useful websites: long-read-tools.org

Grace Software Toolchains

- search for module names using module spider

```
module spider bowtie2
```

- use module spider with module name for details on how to load module

```
module spider Bowtie2/2.4.2
```

- read output to see which other module(s) to load first

```
module load GCC/10.2.0 Bowtie2/2.4.2
```

show loaded modules

```
module list
```

- see what other modules are compatible with the loaded module(s)

```
module avail samtools
```

- load additional compatible modules

```
module load SAMtools/1.11
```

- unload all loaded modules

```
module purge
```

Compatible Toolchains

- See a short table of compatible toolchains and python versions

toolchains

	GCC dependency version		Available Python version
foss/2021.07 =	GCC/11.2.0	OpenMPI/4.1.1	Python/3.9.6
foss/2021a =	GCC/10.3.0	OpenMPI/4.1.1	Python/3.9.5
intel/2021a =	GCC/10.3.0	impi/2020.2.0	Python/3.9.5
foss/2020b =	GCC/10.2.0	OpenMPI/4.0.5	Python/3.8.6
intel/2020b =	GCC/10.2.0	impi/2019.9.304	Python/3.8.6
foss/2020a =	GCC/9.3.0	OpenMPI/4.0.3	Python/3.8.2
intel/2020a =	GCC/9.3.0	impi/2019.7.217	Python/3.8.2
foss/2019b =	GCC/8.3.0	OpenMPI/3.1.4	Python/3.7.4
intel/2019b =	GCC/8.3.0	impi/2018.5.288	Python/3.7.4
foss/2019a =	GCC/8.2.0	OpenMPI/3.1.3	Python/3.7.2
foss/2018b =	GCC/7.3.0	OpenMPI/3.1.1	Python/3.6.6
intel/2018b =	GCC/7.3.0	impi/2018.3.222	Python/3.6.6

loading foss/2019b will also load GCC/8.3.0 and OpenMPI/3.1.4

hprc.tamu.edu/wiki/SW:Toolchains

Use `$TMPDIR` whenever possible

- Use the `$TMPDIR` if the application you are running can utilize a temporary directory for writing temporary files which are deleted when the job ends
- A temp directory (`$TMPDIR`) is automatically assigned for each job which uses the disk(s) on the compute node not the `$SCRATCH` shared file system
 - Especially useful when a computational tool writes tens of thousands of temporary files which are deleted when the job is finished and are not needed for the final results
 - This is useful since files on `$TMPDIR` will not count against your file quota
 - Don't use `$TMPDIR` if your software uses temporary files for restarting where it left off if it should stop before completion
 - Will significantly speed up an mpiBLAST job

```
java -Xmx350g -jar $EBROOTPICARD/FastqToSam.jar TMP_DIR=$TMPDIR \  
FASTQ=$pe1_1 FASTQ2=$pe1_2 OUTPUT=$outfile SAMPLE_NAME=$sample_name \  
SORT_ORDER=$sort_order MAX_RECORDS_IN_RAM='null'
```

Quality Control (QC)

QC Evaluation

- Use FastQC to visualize quality scores
 - Displays quality score distribution of a subset of ~200,000 reads
 - Input is a fastq file or files
 - Can disable grouping (binning) of sequence regions
 - Will alert you of poor read characteristics
 - Can be run as a GUI or a command line interface

```
module load FastQC/0.11.9-Java-11
```

- FastQC will process using one CPU core per file
 - If there are 10 fastq files to analyze and 4 cores used
 - 4 files will start processing and 6 will wait in a queue
 - If there is only one fastq file to process then using 10 cores does not speed up the process

Digital Normalization for Assembly

- Reduce memory requirements by reducing the number of redundant sequence reads if you have a very high sequencing coverage ($> 200x$)
- Used for genome and transcriptome assembly not variant calling or quantitative analysis (ChIP-seq, RNA-seq for expression profiling)
- Trinity 2.4.0+ automatically normalizes reads to a depth of 50x using a modified version of seqtk
- The `bbnorm.sh` script in BBMap can normalize reads
 - use `reformat.sh` to subsample

`module spider BBMap`

Template Job Scripts

<https://hprc.tamu.edu/wiki/SW:GCATemplates>

Access GCATemplates Scripts for Grace and Terra from the HPRC wiki

https://hprc.tamu.edu/wiki/Bioinformatics:Sequence_QC#FastQC

High Performance Research Computing

A Resource for Research and Discovery



TEXAS A&M
UNIVERSITY

Genomic Computational
Analysis Templates

FastQC [edit]

GCATemplates available: [grace](#) & [terra](#)

```
module spider FastQC
```

After running FastQC via the command line, you can ssh to an HPRC cluster enabling X11 forwarding by using the `-X` option and view the images using the `eog` tool.

From your desktop:

```
ssh -X username@grace.hprc.tamu.edu
```

From your FastQC working directory on Grace unzip the `.zip` results file then use `eog` to view the results in the Images directory:

```
eog sample_fastqc/Images/per_sequence_gc_content.png
```

You can also run FastQC interactively using the FastQC GUI by logging in using X11 forwarding and running the command:

```
fastqc
```

Click to see template script on [github.tamu.edu](https://github.com/hprc.tamu.edu)

adding fastqc

Latest commit 944c93e 3 minutes ago [History](#)

0 contributors

Executable File | 44 lines (34 sloc) | 1.9 KB

Raw Blame  

```
1  #!/bin/bash
2  #SBATCH --export=NONE           # do not export current env to the job
3  #SBATCH --job-name=fastqc      # job name
4  #SBATCH --time=01:00:00       # max job run time dd-hh:mm:ss
5  #SBATCH --ntasks-per-node=1   # tasks (commands) per compute node
6  #SBATCH --cpus-per-task=2     # CPUs (threads) per command
7  #SBATCH --mem=14G             # total memory per node
8  #SBATCH --output=stdout.%j    # save stdout to file
9  #SBATCH --error=stderr.%j     # save stderr to file
10
11 module load FastQC/0.11.9-Java-11
12
13 <<README
14   - FASTQC homepage: http://www.bioinformatics.babraham.ac.uk/projects/fastqc
15   - FASTQC manual: http://www.bioinformatics.babraham.ac.uk/projects/fastqc/Help
16 README
17
18 ##### VARIABLES #####
19 # TODO Edit these variables as needed:
20
```



Click Raw if you want to copy and paste from your web browser

Finding NGS job template scripts using GCATemplates on HPRC clusters

Genomic Computational Analysis Templates

```
mkdir $SCRATCH/ngs_class
```

```
cd $SCRATCH/ngs_class
```

```
gcatemplates
```

For practice, we will copy a template file

- Select #2 then find the template that contains fastqc
 - or use the search to find fastqc
- Final step will save a template job script file to your current working directory

```
BIOINFORMATICS GCATemplates (grace)

CATEGORY
1. FASTA files
2. FASTQ files (QC, trim, SRA)
3. Genome assembly
4. Metagenomics
5. PacBio tools
6. Phylogenetics
7. RNA-seq
8. SNPs & indels
9. Sequence alignments
10. Simulate data

s search
q quit

Select:2
```

Sample GCATemplate Job Script (Grace)

```
#!/bin/bash
#SBATCH --export=NONE           # do not export current env to the job
#SBATCH --job-name=fastqc      # job name
#SBATCH --time=01:00:00       # max job run time dd-hh:mm:ss
#SBATCH --ntasks-per-node=1   # tasks (commands) per compute node
#SBATCH --cpus-per-task=2     # CPUs (threads) per command
#SBATCH --mem=4G              # total memory per node
#SBATCH --output=stdout.%j    # save stdout to file (%j is jobid)
#SBATCH --error=stderr.%j     # save stderr to file (%j is jobid)

module load FastQC/0.11.9-Java-11

<<README
- FASTQC manual: http://www.bioinformatics.babraham.ac.uk/projects/fastqc/Help
README
##### VARIABLES #####
# TODO Edit these variables as needed:
##### INPUTS #####
pe1_1='/scratch/data/bio/GCATemplates/data/miseq/c_dublinsiensis/DR34_R1.fastq.gz'
pe1_2='/scratch/data/bio/GCATemplates/data/miseq/c_dublinsiensis/DR34_R2.fastq.gz'

##### PARAMETERS #####
threads=$SLURM_CPUS_PER_TASK

##### OUTPUTS #####
output_dir='./'

##### COMMANDS #####
fastqc -t $threads -o $output_dir $pe1_1 $pe1_2

<<CITATION
- Acknowledge TAMU HPRC: https://hprc.tamu.edu/research/citations.html
- FastQC: http://www.bioinformatics.babraham.ac.uk/projects/fastqc
CITATION
```

Sample GCATemplate Job Script (Grace)

```
#!/bin/bash
#SBATCH --export=NONE           # do not export current env to the job
#SBATCH --job-name=fastqc      # job name
#SBATCH --time=01:00:00        # max job run time dd-hh:mm:ss
#SBATCH --ntasks-per-node=1    # tasks (commands) per compute node
#SBATCH --cpus-per-task=2      # CPUs (threads) per command
#SBATCH --mem=4G               # total memory per node
#SBATCH --output=stdout.%j     # save stdout to file (%j is jobid)
#SBATCH --error=stderr.%j      # save stderr to file (%j is jobid)
```

These parameters are read by the job scheduler

```
module load FastQC/0.11.9-Java-11
```

Load the required module(s) first

```
<<README
```

```
- FASTQC manual: http://www.bioinformatics.babraham.ac.uk/projects/fastqc/Help
```

```
README
```

```
##### VARIABLES #####
```

```
# TODO Edit these variables as needed:
```

```
##### INPUTS #####
```

```
pe1_1='/scratch/data/bio/GCATemplates/data/miseq/c_dublinsiensis/DR34_R1.fastq.gz'
```

```
pe1_2='/scratch/data/bio/GCATemplates/data/miseq/c_dublinsiensis/DR34_R2.fastq.gz'
```

```
##### PARAMETERS #####
```

```
threads=$SLURM_CPUS_PER_TASK
```

This is a single line comment and not run as part of the script

```
##### OUTPUTS #####
```

```
output_dir='./'
```

```
##### COMMANDS #####
```

```
fastqc -t $threads -o $output_dir $pe1_1 $pe1_2
```

This is the command to run the application

```
<<CITATION
```

```
- Acknowledge TAMU HPRC: https://hprc.tamu.edu/research/citations.html
```

```
- FastQC: http://www.bioinformatics.babraham.ac.uk/projects/fastqc
```

```
CITATION
```

FastQC Exercise

- Use the GCATemplate for FastQC to submit a job evaluating the two sequence files
 - `gedit run_fastqc_0.11.9_grace.sh &`
 - `sbatch run_fastqc_0.11.9_grace.sh`
- After your fastqc job is complete, unzip the results file and you can view the results files with **lynx** and **eog** (eog requires X11 login; if using the portal, use the Files app to view images)
 - `unzip DR34_R1_fastqc.zip`

FastQC Report using lynx

```
DR34_R1.fastq.gz FastQC Report (pl of 4)
FastQC FastQC Report
Wed 9 Mar 2016
DR34_R1.fastq.gz

lynx DR34_R1_fastqc.html

Summary

* [PASS] Basic Statistics
* [PASS] Per base sequence quality
* [PASS] Per tile sequence quality
* [PASS] Per sequence quality scores
* [FAIL] Per base sequence content
* [PASS] Per sequence GC content
* [PASS] Per base N content
* [WARNING] Sequence Length Distribution
* [PASS] Sequence Duplication Levels
* [WARNING] Overrepresented sequences
* [PASS] Adapter Content
* [FAIL] Kmer Content

[OK] Basic Statistics

      Measure                               Value
Filename                               DR34_R1.fastq.gz
File type                               Conventional base calls
Encoding                               Sanger / Illumina 1.9
Total Sequences                         946744
Sequences flagged as poor quality       0
Sequence length                         35-251
%GC                                      39

-- press space for next page --
Arrow keys: Up and Down to move. Right to follow a link; Left to go back.
H)elp O)ptions P)rint G)o M)ain screen Q)uit /=search [delete]=history list
```



FastQC Output Image Quality Distribution

eog DR34_R1_fastqc/Images/per_base_quality.png

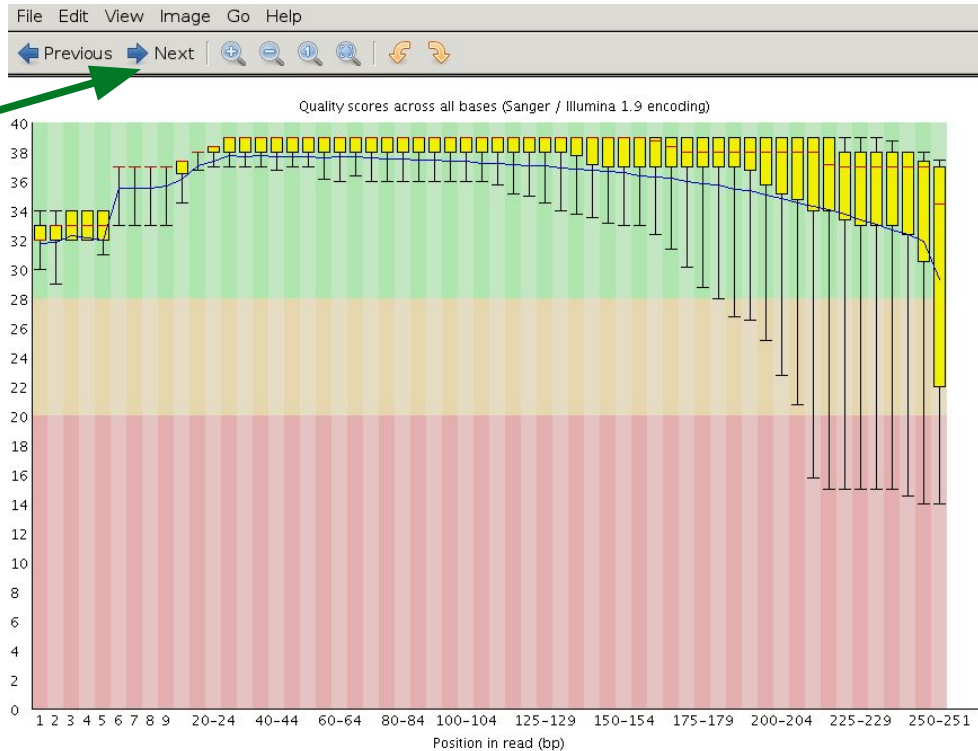

FastQC Output Image Quality Distribution

FASTQ format

```
@ERR504787.2.1 M00368:15:000000000-A0HKH:1:5:21261:10968-1 length=100
GATCGGAAGAGCACACGTCTGAACTCCAGTCACGATCAGATCTCGTATGCCGTCTTCTGCTTGAAAAA
+ERR504787.2.1 M00368:15:000000000-A0HKH:1:5:21261:10968-1 length=100
==4AD=B8A:+=A: :1<:AE<C3*?F<B???<?:8:6?B*9BD;/638.=-'-.@7=) .=A:6?DDDC
@ERR504787.3.1 M00368:15:000000000-A0HKH:1:3:12724:25677-1 length=100
GATGTTTTGTTACTGATTGGAACCATGATTGGTGCTTTACTTGGTTTCTTCCTATTTAACCACAAGCCTG
+ERR504787.3.1 M00368:15:000000000-A0HKH:1:3:12724:25677-1 length=100
BCCFDEFFHHHHHJJJJJJJJJJJJJJJJJJJJJJJJJJJJJJJJJJJJJJJJJJJJJJJJJJJJJJJJ
@ERR504787.5.1 M00368:15:000000000-A0HKH:1:2:16161:12630-1 length=100
TATTTTAAGTGACCAAGGAATGACTCCCCAATCATGGCTGTATCAACTCCAAAATTTTCTGCAACAGT
+ERR504787.5.1 M00368:15:000000000-A0HKH:1:2:16161:12630-1 length=100
CCCCFFFFHHHHHJJJJJJJJJJJJJJJJJJJJJJJJJJJJJJJJJJJJJJJJJJJJJJJJJJJJJJJJ
```

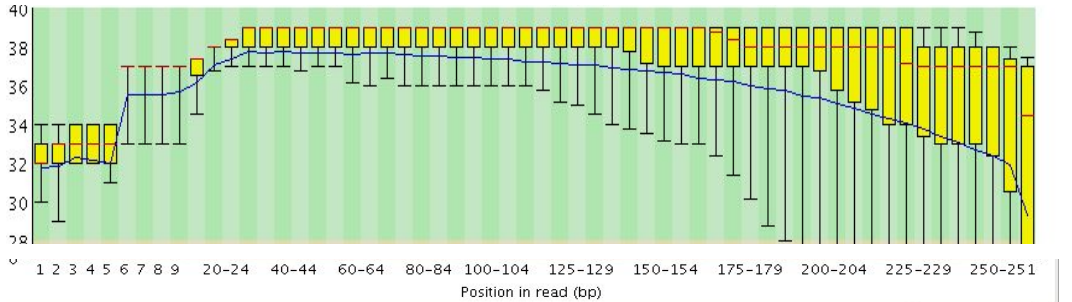

FastQC Output Image Quality Distribution

FASTQ format

```
@ERR504787.2.1 M00368:15:000000000-A0HKH:1:5:21261:10968-1 length=100
GATCGGAAGAGCACACGTCTGAACTCCAGTCACGATCAGATCTCGTATGCCGTCTTCTGCTTGAAAAA
+ERR504787.2.1 M00368:15:000000000-A0HKH:1:5:21261:10968-1 length=100
!:=4AD=B8A:+<A:.:1<:AE<C3*?F<B*??<?::8:6?B*9BD;/638.--'-.@7=)!.=A:6?DDDCBB
@ERR504787.3.1 M00368:15:000000000-A0HKH:1:3:12724:25677-1 length=100
GATGTTTTGTTACTGATTGGAACCATGATTGGTGCCTTACTTGGTTTTCTTCCTATTTAACCAAGCCTGCC
+ERR504787.3.1 M00368:15:000000000-A0HKH:1:3:12724:25677-1 length=100
BCCFDEFHHHHHHJJJJJJJJJJJJJJJJJJJJJJJJJJJJJJJJJJJJJJJJJJJJJJJJJJJJJJJJJJJJJJJ
@ERR504787.5.1 M00368:15:000000000-A0HKH:1:2:16161:12630-1 length=100
TATTTTAAGTGACCAAGGAATGACTCCCAATCATGGCTGTATCAACTCCAAAATTTCTGCAACAGTCGCTGAA
+ERR504787.5.1 M00368:15:000000000-A0HKH:1:2:16161:12630-1 length=100
CCCCFFFFHHHHHHJJJJJJJJJJJJJJJJJJJJJJJJJJJJJJJJJJJJJJJJJJJJJJJJJJJJJJJJJJJJJJJ
```

Average quality score distribution at position one

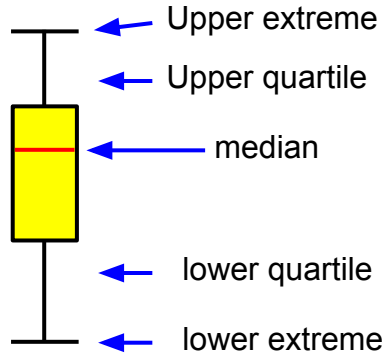
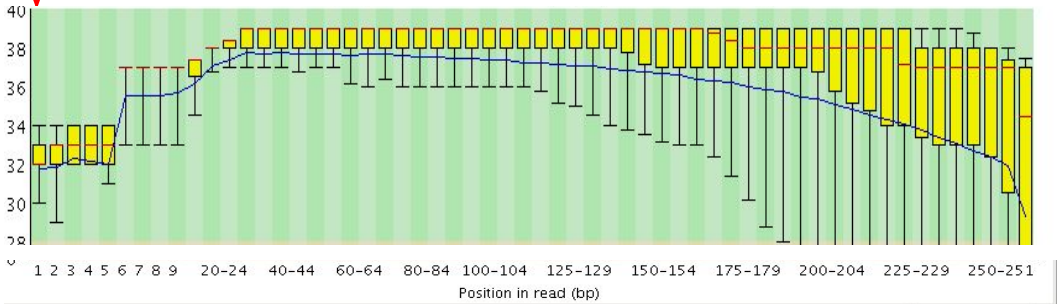

FastQC Output Image Quality Distribution

FASTQ format

```
@ERR504787.2.1 M00368:15:000000000-A0HKH:1:5:21261:10968-1 length=100
GATCGGAAGAGCACACGTCTGAACTCCAGTCACGATCAGATCTCGTATGCCGTCTTCTGCTTGAAAAA
+ERR504787.2.1 M00368:15:000000000-A0HKH:1:5:21261:10968-1 length=100
==4AD=B8A:+=A::1<:AE<C3*?F<B???<?:8:6?B*9BD;/638.-'-.@7=) .=A:6?DDDCBB
@ERR504787.3.1 M00368:15:000000000-A0HKH:1:3:12724:25677-1 length=100
GATGTTTTGTTACTGATTGGAACCATGATTGGTGCTTTACTTGGTTTCTTCTTATTTAACCACAAGCCT
+ERR504787.3.1 M00368:15:000000000-A0HKH:1:3:12724:25677-1 length=100
BCCFDEFFHHHHHJJJJJJJJJJJJJJJJJJJJJJJJJJJJJJJJJJJJJJJJJJJJJJJJJJJJJJJJ
@ERR504787.5.1 M00368:15:000000000-A0HKH:1:2:16161:12630-1 length=100
TATTTTAAGTGACCAAGGAATGACTCCCAATCATGGCTGTATCAACTCCAAAATTTTCTGCAACAGT
+ERR504787.5.1 M00368:15:000000000-A0HKH:1:2:16161:12630-1 length=100
CCCFFFFHHHHHJJJJJJJJJJJJJJJJJJJJJJJJJJJJJJJJJJJJJJJJJJJJJJJJJJJJJJJJ
```

Positions are 'binned' after the first few positions

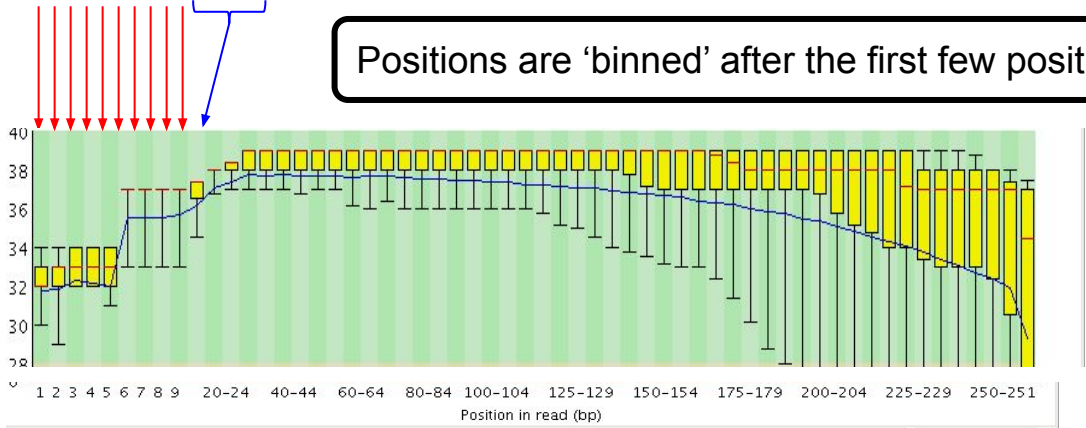

Illumina Transposon Insertion Site

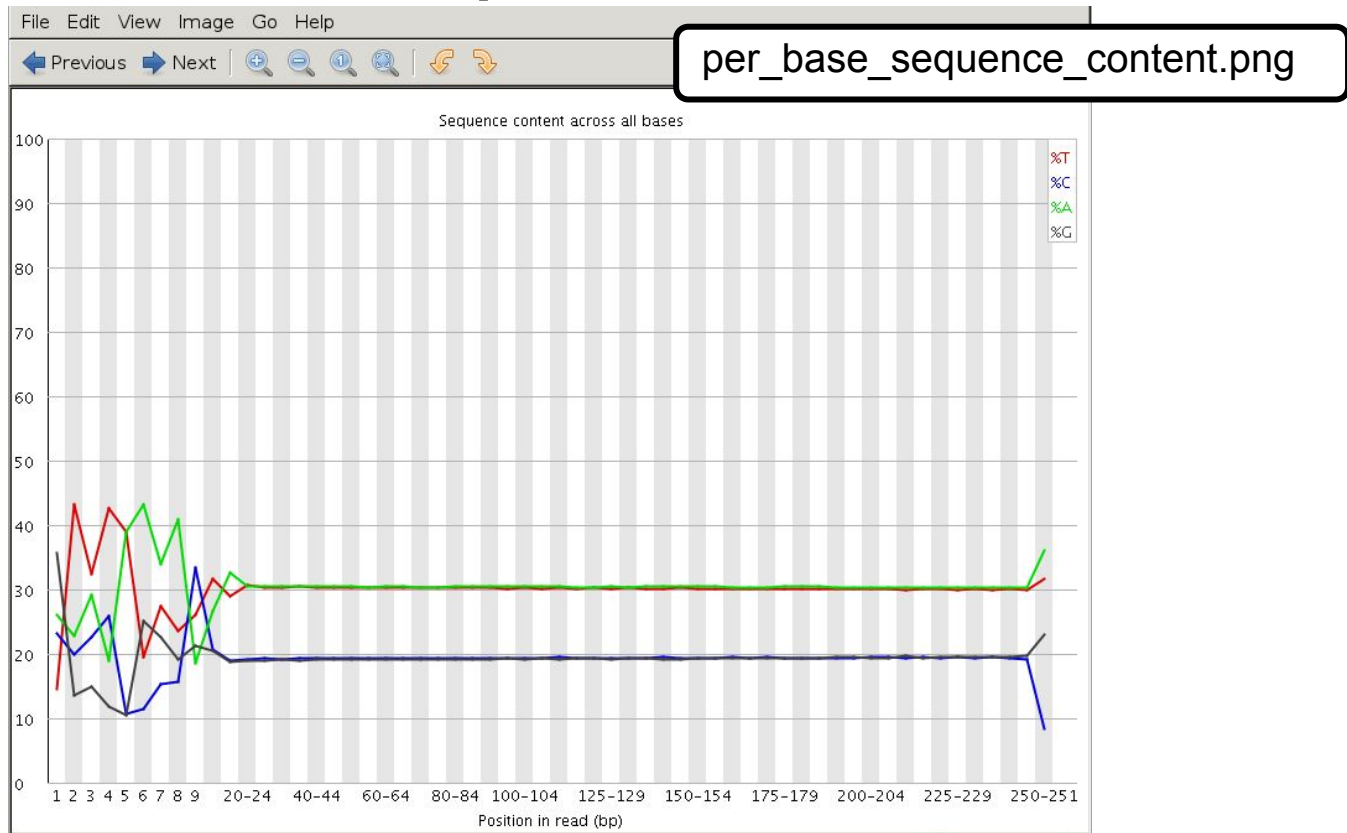

Illumina Transposon Insertion Site

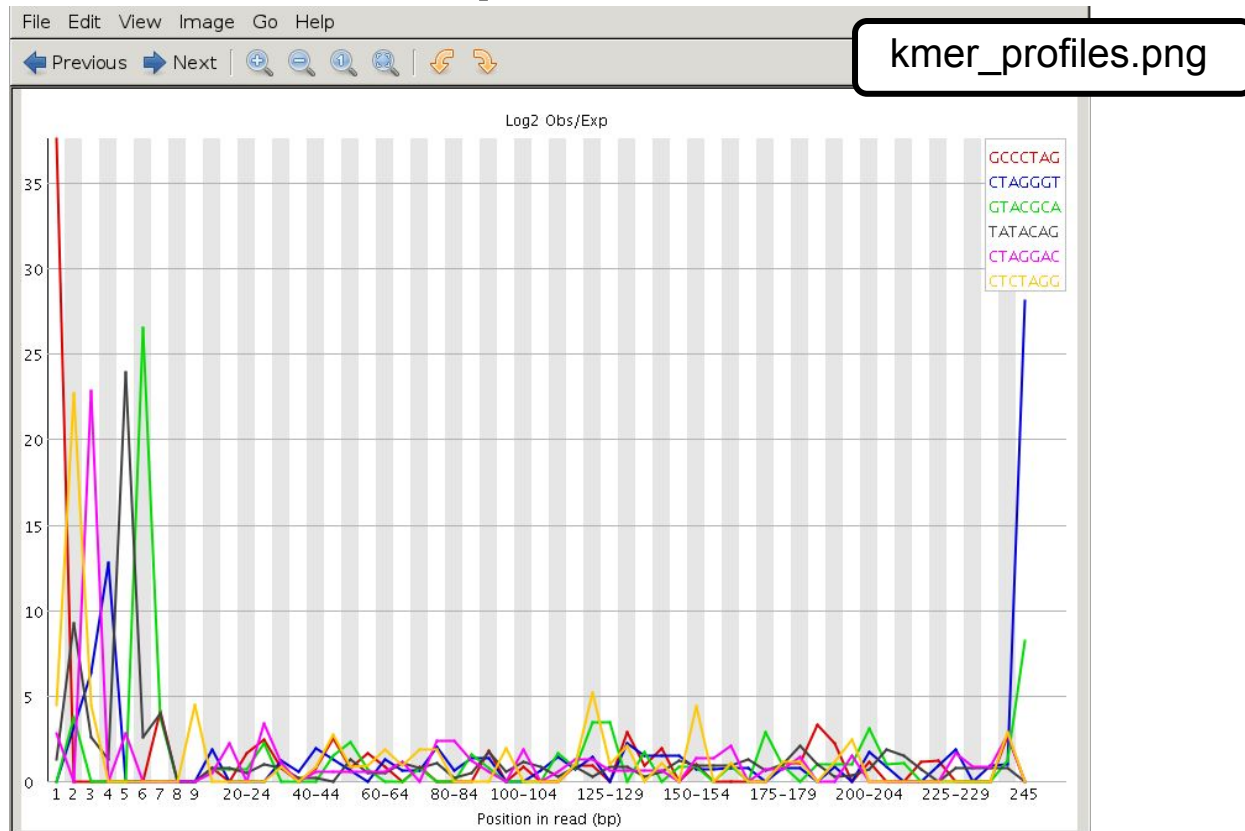

FastQC Flowcell Quality Image

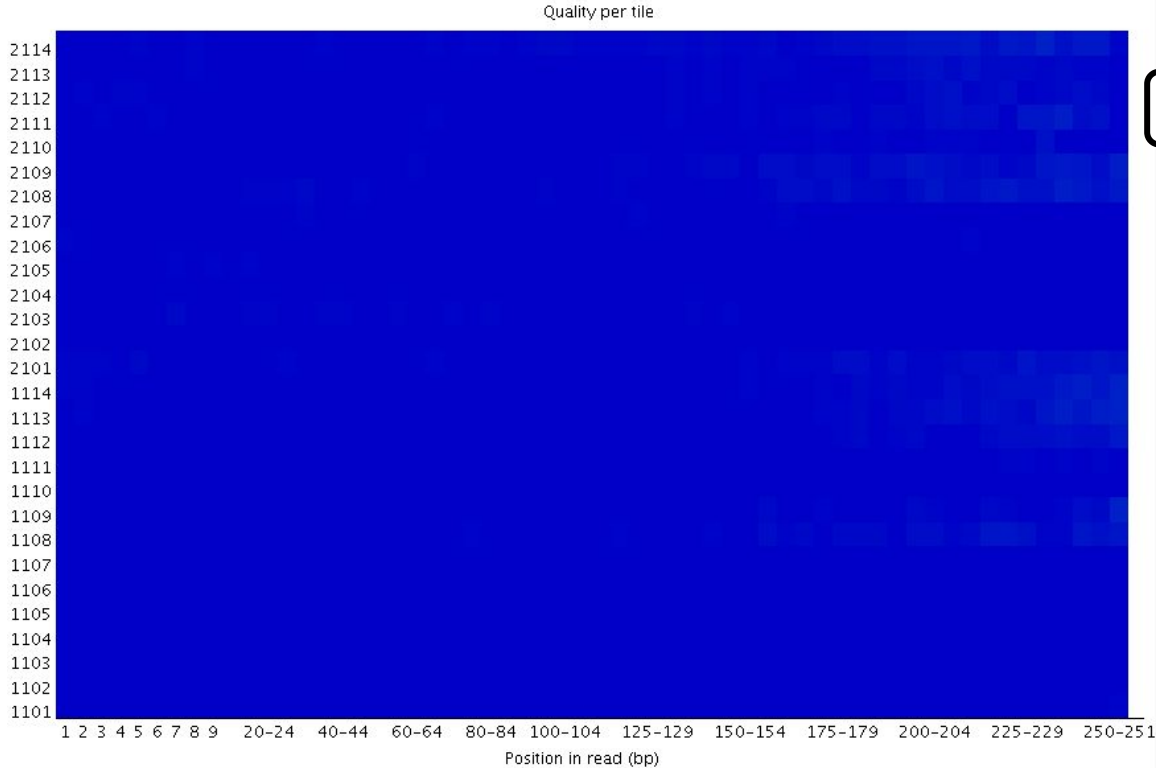

per_tile_quality.png

Flowcell quality mapping
Good per_tile quality

MiSeq flowcell

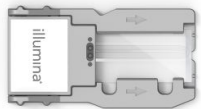

good quality



poor quality

FastQC Flowcell Quality Image

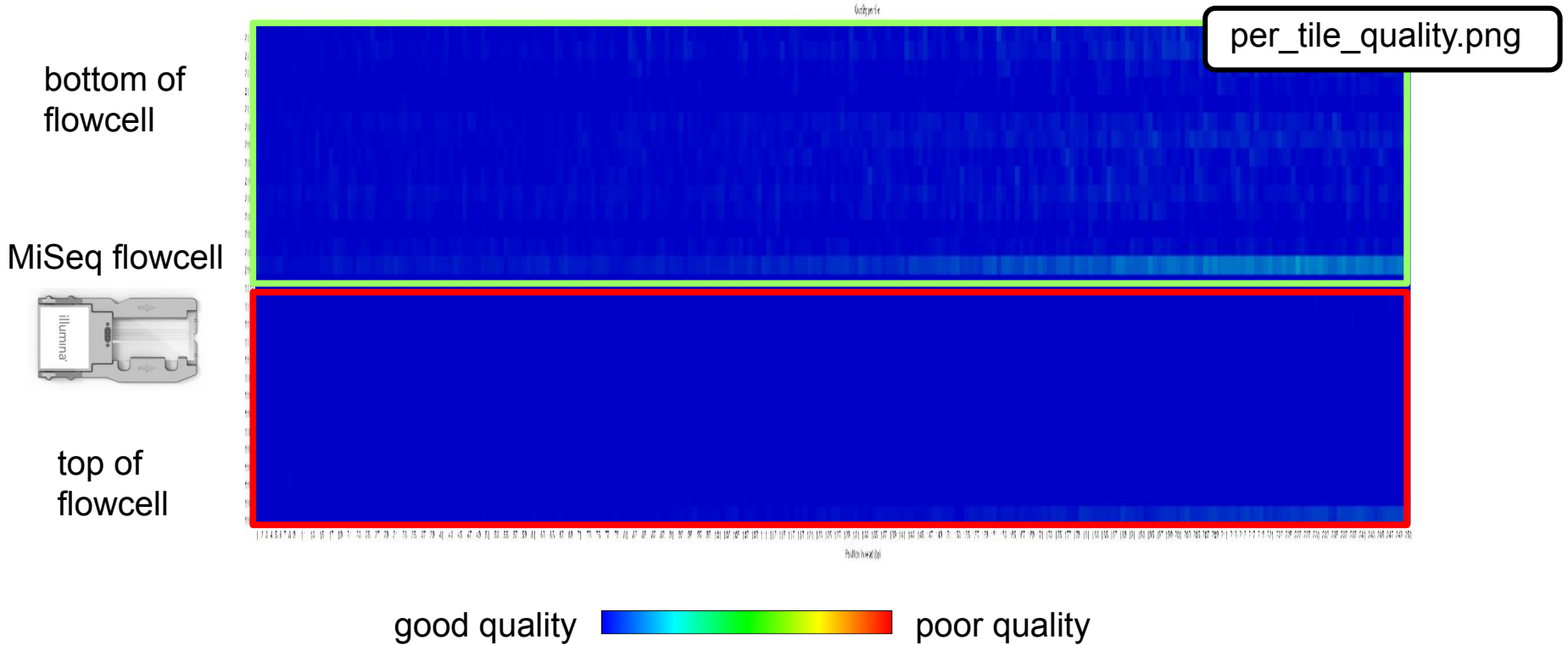

Failed QC Examples

FastQC Output Image

Failed Per base sequence quality

Example 1. Expired MiSeq mate-pair kit (9 months expired)

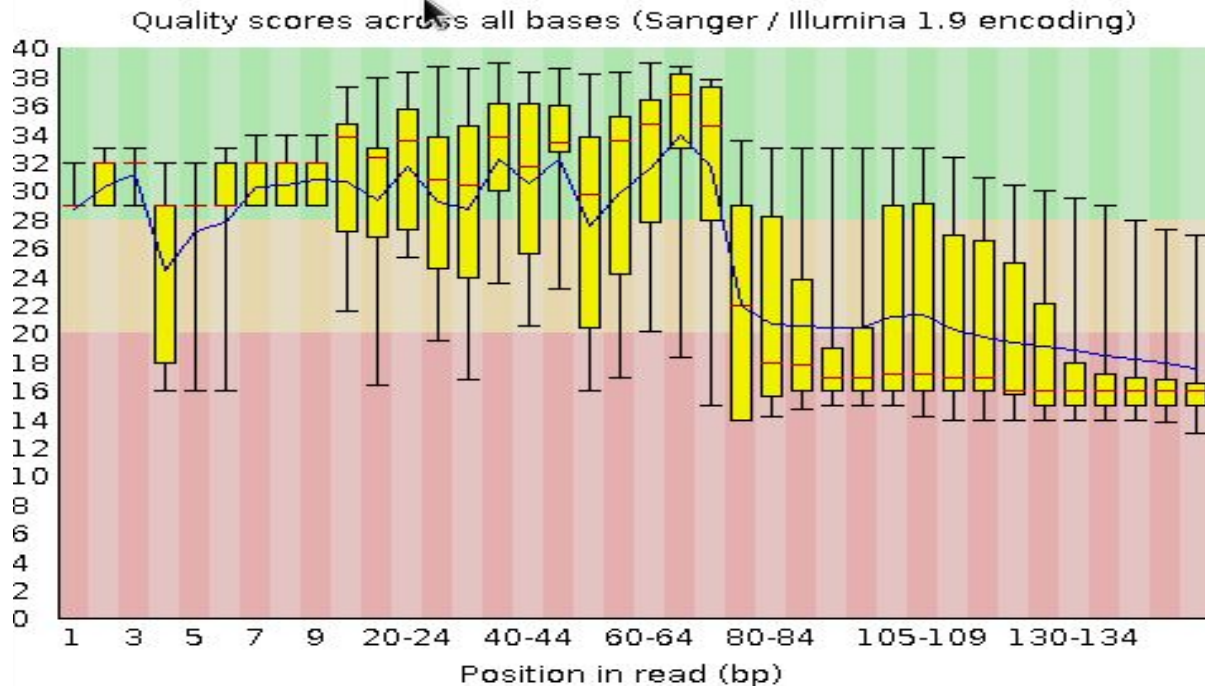

FastQC Output Image

Failed Kmer Content

Example 2. Sequence prep adapters still on ends of DNA library fragments

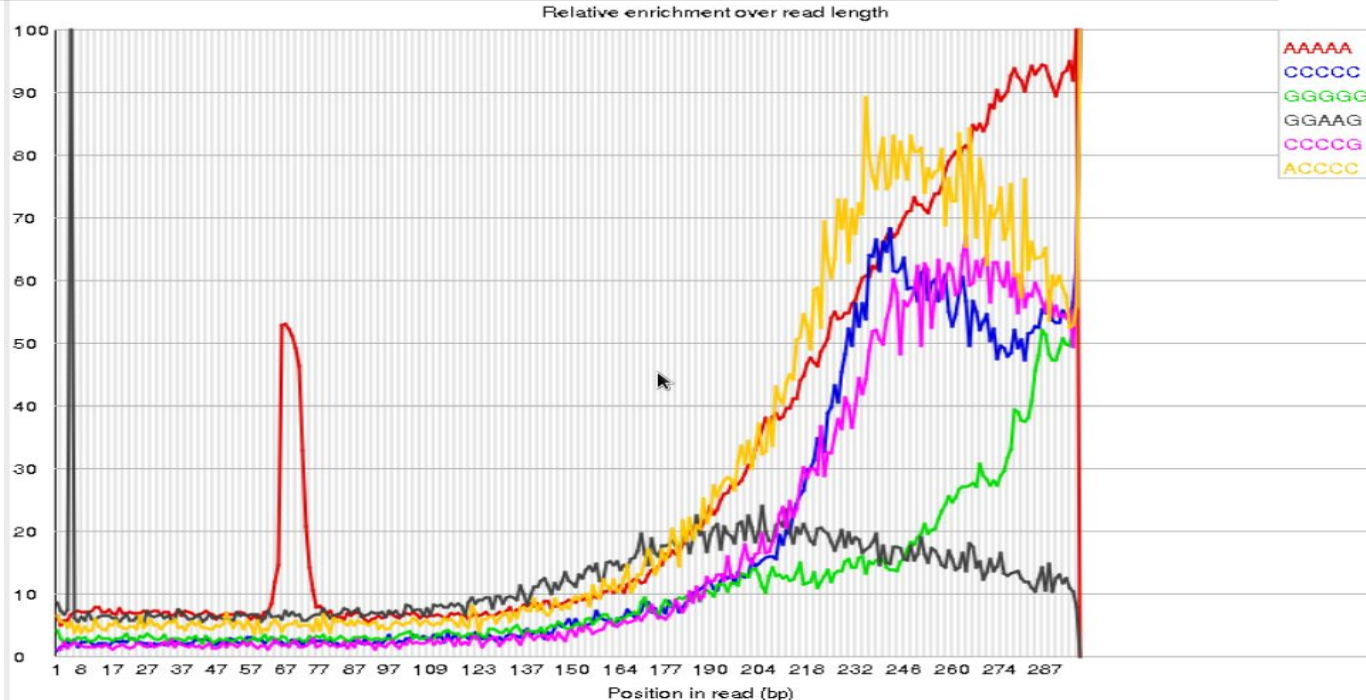

FastQC Output Image

Flowcell: not good per_tile quality

Example 3. Faulty flowcell

MiSeq flowcell

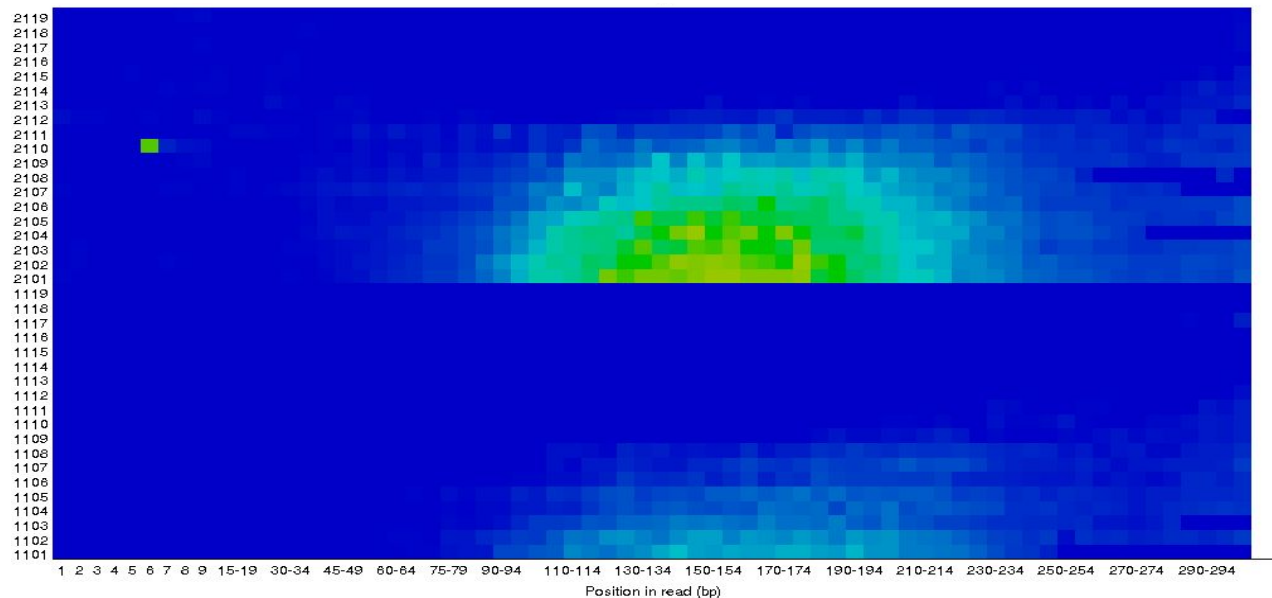

good quality  poor quality

QC Quality Trimming

- Sequence quality trimming tools

```
module spider Trimmomatic
```

← recommended tool

- Trimmomatic will maintain paired end read pairing after trimming
- Trim reads based on quality scores
 - Trim the same number of bases from each read or
 - Use a sliding window to calculate average quality at ends of sequences
- Decide if you want to discard reads with Ns
 - some assemblers replace Ns with As or a random base G, C, A or T
- Trim adapter sequences
 - Trimmomatic has a file of Illumina adapter sequences

```
module load Trimmomatic/0.39-Java-11
```

```
ls $EBROOTTRIMMOMATIC/adapters/
```

Paired End Short Reads

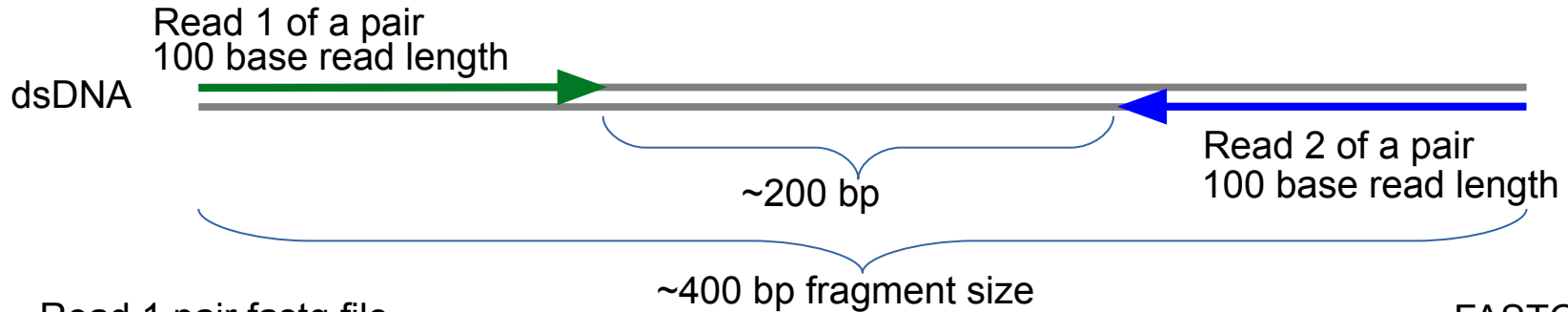

Read 1 pair fastq file

FASTQ format

```
@M00861:1:000000000-A36BE:1:1101:14650:1529 1:N:0:8
TTCTTAAAAATACCATAAAAGGCTTAAACTTGCCATTTACGACGGATTAATTCCAACCTTTTTCGGCTATCTTCATCTTTAAGGTAAATGACTCATAACGG
+
FFFHBBFFHHIIIIIIHFHHCGEFGHHIHHHIHD/?DGGHHH@DEB,5EGHGHIIHIF?FGGHHCCBFDGHFHDGHGFFFFGDFHH?DFHDFHHHFHFFHHH
```

Read 2 pair fastq file

```
@M00861:1:000000000-A36BE:1:1101:14650:1529 2:N:0:8
ACTAAAAATCAATTTTATCAATTTCAAGCTCTACCTTATTTACTCATTATTTTAGTGATGGCCACTTTAATAAAAAATATTGGTAGCATATTTGCAATAGCGG
+
BFFHIHHHFHHDGHIHHIHHHGHHHHHFFHDFHHIHI I IHIHDFHHHIHI I IH=AAFHI I IHFGFHHHHHGGHHIHHFGFFFEGGHHHDGHHH/CGHIFHHH
```

dsDNA



Trimming PE Short Sequence Reads

File 1 from sequencer



100 bases



100 bases

File 2 from sequencer

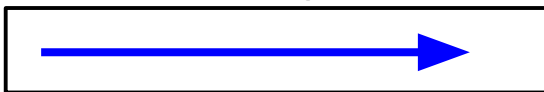

100 bases

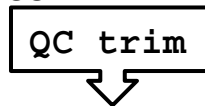

50 bases

minimum read length = 40

Resulting FASTQ Files with trimmed reads

Paired end 1 trimmed file



Paired end 2 trimmed file



dsDNA



Trimming PE Short Sequence Reads

File 1 from sequencer



100 bases



100 bases

File 2 from sequencer



100 bases

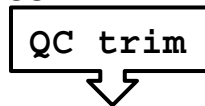

20 bases

minimun read length = 40

Resulting FASTQ Files with trimmed reads

Paired end 1 trimmed file



Paired end 2 trimmed file



Single end reads



Merge Overlapping Paired End Short Reads

fragment 1

dsDNA



fragment 2

dsDNA



Merge Overlapping Paired End Short Reads

fragment 1



fragment 2



Paired end read 1 (left)



Paired end read 2 (right)

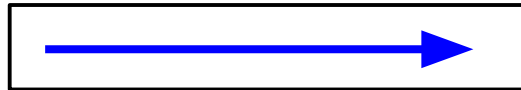

Merge Overlapping Paired End Short Reads

fragment 1



fragment 2



Paired end read 1 (left)



Paired end read 2 (right)



Unpaired 'merged' read



Tools for merging overlapping reads:

`module spider FLASH`

`module spider Coperead`

`module spider BMap`

`module spider PEAR`

Mapping Reads to a Reference Assembly

Mapping Short Reads to a Reference Assembly

- Align reads using bwa

```
module spider BWA
```

- Align reads using bowtie or bowtie2

```
module spider Bowtie
```

```
module spider Bowtie2
```

- genome index files for found here:

```
/scratch/data/bio/genome_indexes/
```

Send an email to help@hprc.tamu.edu if you need and index that is not found in the genome_indexes directory

Visualize bam Alignment Files

Sample bam and reference files

```
cd $SCRATCH/ngs_class
```

For this samtools demo, add symbolic links* to the example files in your working directory

```
ln -s /scratch/data/bio/training/alignments/dr34.sam
```

Add a symbolic link to the example reference genome fasta file

```
ln -s /scratch/data/bio/training/genomes/c_dublinsiensis.fa
```

Use the tab key when typing these long paths

* The symbolic links are used to make the commands shorter for demonstration purposes only. You do not need to make symbolic links in order to use `samtools tview`

Sorting Alignment sam/bam Files

- Sequence Alignment/Map format (sam)
 - view sam files using the UNIX command: `more dr34.sam`
- Binary Alignment/Map format (bam)
 - Compressed (binary) sam files need samtools to view
 - `module load GCC/10.2.0 SAMtools/1.11`
 - Recommended: sort sam/bam file based on coordinate into bam format
 - `samtools sort -@ 1 -m 2G -o dr34.bam dr34.sam`
 - Create an index of the bam file using samtools
 - A samtools index is needed prior to viewing bam files in browsers

```
samtools index dr34.bam
```

```
dr34.bam.bai
```

Viewing sam/bam Files

Viewing bam files using samtools

```
samtools view dr34.bam | more
```

view only alignments

```
samtools view -H dr34.bam
```

view only header

```
samtools view -h dr34.bam | more
```

view header + alignments

Sam Flags and Bits

- Flags describe alignments (the flag value is the sum of bits)

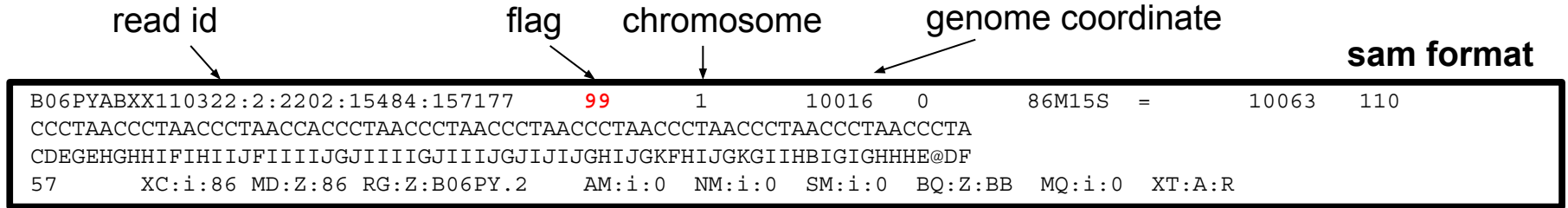

bits: 1 2 4 8 16 32 64 128 256 512 1024 2048

$$1 + 2 + 32 + 64 = 99$$

- Filter bam alignments based on bit in flag (-f and/or -F)

- Keep only reads that are 'mapped in proper pair'

```
samtools view -h -b -f 2 dr34.bam > dr34_paired_reads.bam
```

- Keep all except reads that are 'PCR or optical duplicate'

```
samtools view -h -b -F 1024 dr34.bam > dr34_dedup_reads.bam
```

Sam Flags and Bits

<https://broadinstitute.github.io/picard/explain-flags.html>

Decoding SAM flags

This utility makes it easy to identify what are the properties of a read based on its SAM flag value, or conversely, to find what the SAM Flag value would be for a given combination of properties.

To decode a given SAM flag value, just enter the number in the field below. The encoded properties will be listed under Summary below, to the right.

SAM Flag:

Toggle first in pair/ second in pair

Find SAM flag by property:

To find out what the SAM flag value would be for a given combination of properties, tick the boxes for those that you'd like to include. The flag value will be shown in the SAM Flag field above.

1	<input checked="" type="checkbox"/>	read paired
2	<input checked="" type="checkbox"/>	read mapped in proper pair
4	<input type="checkbox"/>	read unmapped
8	<input type="checkbox"/>	mate unmapped
16	<input type="checkbox"/>	read reverse strand
32	<input checked="" type="checkbox"/>	mate reverse strand
64	<input checked="" type="checkbox"/>	first in pair
128	<input type="checkbox"/>	second in pair
256	<input type="checkbox"/>	not primary alignment
512	<input type="checkbox"/>	read fails platform/vendor quality checks
1024	<input type="checkbox"/>	read is PCR or optical duplicate
2048	<input type="checkbox"/>	supplementary alignment

Summary:

- read paired
- read mapped in proper pair
- mate reverse strand
- first in pair

SAM Flag is the sum of Bits

$$99 = 64 + 32 + 2 + 1$$

Alignment Statistics

```
samtools flagstat dr34.bam
```

```
150000 + 0 in total (QC-passed reads + QC-failed reads)
0 + 0 secondary
0 + 0 supplementary
0 + 0 duplicates
140150 + 0 mapped (93.43% : N/A)
150000 + 0 paired in sequencing
75002 + 0 read1
74998 + 0 read2
85639 + 0 properly paired (57.09% : N/A)
136854 + 0 with itself and mate mapped
3296 + 0 singletons (2.20% : N/A)
909 + 0 with mate mapped to a different chr
56 + 0 with mate mapped to a different chr (mapQ>=5)
```

Both reads in the pair are mapped
on the same chromosome
and in FR or RF orientation



SAMtools with a Reference Genome

Reference genome sequence displayed on top when reference file is provided

```
samtools tview dr34.bam c_dublinsiensis.fa
```



```
1      11      21      31      41      51      61      71      81      91      101     111     121     131
GATCAAGTTGAGAGACAAATAGAGTTGTTTATTTAATTACAGAGAAGAATCAGTTGTTTCATTGTTAAGATCACAGACAGAATTCTGTTGTTTGTAGTCGCAAAGAATCAGCTACAATACAGTTAGAGATACAGTATA
```

SAMtools with a Reference Genome

Type ? for help menu

```
samtools tview dr34.bam c_dubliniensis.fa
```



```
1      11      21      31      41      51      61      71      81      91      101     111     121     131
GATCAAGTTGAGAGACAAATAGAGTTGTTTATTTTAAATTCAGAGAAGAATCAGTTGTTTATTGTTAAAGATCACAGACAGAATCTCTGTTGTTTGTAGTCGCAAAAGAATCAGCTACAATACAGTTAGAGATACAGTATA

-----
|                                     |
|      ==      Help      ==      |
|                                     |
| ?            This window         |
| Arrows       Small scroll movement |
| h,j,k,l     Small scroll movement |
| H,J,K,L     Large scroll movement  |
| ctrl-H      Scroll 1k left        |
| ctrl-L      Scroll 1k right       |
| space       Scroll one screen     |
| backspace   Scroll back one screen|
| g           Go to specific location|
| m           Color for mapping qual |
| n           Color for nucleotide   |
| b           Color for base quality  |
| c           Color for cs color     |
| z           Color for cs qual      |
| .           Toggle on/off dot view |
| s           Toggle on/off ref skip |
| r           Toggle on/off rd name  |
| N           Turn on nt view        |
| C           Turn on cs view        |
| i           Toggle on/off ins      |
| v           Inverse video          |
| q           Exit                   |
|                                     |
| Underline:  Secondary or orphan   |
| Blue:       0-9   Green: 10-19    |
| Yellow:    20-29  White: >=30    |
|                                     |
|-----|
```

View at a Specific Coordinate

```
samtools tview dr34.bam c_dublinsiensis.fa -p 1:315398
```

```
315401 315411 315421 315431 315441 315451 315461 315471 315481 315491 315501 315511 315521
CGATGTCAAGATAAACAATAGTCATGTTTCTGATGGGTCTAATTTTACGATTACAATCATCGGATGATGAAATTACTGGAAATCAGGGTGATGCCAGTGGTGTAGGTGGTAGAAAATCACCTAATTATATCAAGAATG
A
a.....,a,a.....a.....a.....
a.....
A.....
a.....
```

homozygous SNP at
coordinate 1:315398

- . = matches the forward strand
- , = matches the reverse strand
- A = does not match reference; read on forward strand
- a = does not match reference; read on reverse strand
- _ = secondary alignment

Sequence Variant Calling

Sequence Variant Calling

- Start with aligning reads to a reference
 - GATK does not require QC trimming
 - Mark PCR duplicates with Picard
- Differentiate between sequencing errors and SNPs
 - Calling SNPs may require a min read depth of 10x (higher for indels)
 - Calling variants may require 1/3 of reads to contain SNP
 - Strand bias may result as a consequence of the sequencing chemistry's response to certain DNA sequence motifs but it can be detected computationally
- BLAST reads with SNPs to identify variant calls due to misalignments especially with duplicated genes
- Variant Call Format (vcf) – standard format of variant calls
- Identify multiple-nucleotide polymorphism (MNP)
 - Two SNPs within a single codon

	codon	translation
Reference:	TTT	Phe
SNP 1:	TTA	Leu
SNP 2:	TAT	Tyr
SNP 1 + 2:	TAA	STOP

Marking PCR Duplicates

- PCR duplicates are artifacts resulting from a PCR amplification step during NGS library preparations.
- PCR duplicates should be removed/marked as to not bias the frequency of variants or gene expression levels
 - Use picard tools to mark duplicates
 - Freebayes will ignore marked duplicates during variant calling

```
module spider picard
```

Variant Calling Tools

Use bam file of sequence reads aligned to a reference as input for the following four work flows

1. GATK `module spider GATK picard SAMtools`
 - No need to QC trim reads, the GATK best practices pipeline will perform the necessary steps including marking PCR duplicates
 - You need a set of known variants for your species (dbSNP) or you can bootstrap your population to get variant frequency
 - Used in conjunction with other tools
 - samtools
 - picard
2. SAMtools and BCFtools `module spider SAMtools BCFtools`
3. FreeBayes `module spider FreeBayes`
4. VarScan `module spider VarScan`

Sample vcf File Format

```
##fileformat=VCFv4.0
##fileDate=20110705
##reference=1000GenomesPilot-NCBI37
##phasing=partial
##INFO=<ID=NS,Number=1,Type=Integer,Description="Number of Samples With Data">
##INFO=<ID=DP,Number=1,Type=Integer,Description="Total Depth">
##INFO=<ID=AF,Number=.,Type=Float,Description="Allele Frequency">
##INFO=<ID=AA,Number=1,Type=String,Description="Ancestral Allele">
##INFO=<ID=DB,Number=0,Type=Flag,Description="dbSNP membership, build 129">
##INFO=<ID=H2,Number=0,Type=Flag,Description="HapMap2 membership">
##FILTER=<ID=q10,Description="Quality below 10">
##FILTER=<ID=s50,Description="Less than 50% of samples have data">
##FORMAT=<ID=GQ,Number=1,Type=Integer,Description="Genotype Quality">
##FORMAT=<ID=GT,Number=1,Type=String,Description="Genotype">
##FORMAT=<ID=DP,Number=1,Type=Integer,Description="Read Depth">
##FORMAT=<ID=HQ,Number=2,Type=Integer,Description="Haplotype Quality">
#CHROM POS ID REF ALT QUAL FILTER INFO FORMAT Sample1 Sample2
2 4370 rs6057 G A 29 . NS=2;DP=13;AF=0.5;DB;H2 GT:GQ:DP:HQ 0|0:48:1:52,51 1|0:48:8:51,51
2 7330 . T A 3 q10 NS=5;DP=12;AF=0.017 GT:GQ:DP:HQ 0|0:46:3:58,50 0|1:3:5:65,3
2 110696 rs6055 A G,T 67 PASS NS=2;DP=10;AF=0.333,0.667;AA=T;DB GT:GQ:DP:HQ 1|2:21:6:23,27 2|1:2:0:18,2
2 130237 . T . 47 . NS=2;DP=16;AA=T GT:GQ:DP:HQ 0|0:54:7:56,60 0|0:48:4:56,51
2 134567 microsat1 GTCT G,GTACT 50 PASS NS=2;DP=9;AA=G GT:GQ:DP 0/1:35:4 0/2:17:2
```

3 more columns not shown due to width of rows

vcf File Column Descriptions

```
##fileformat=VCFv4.0
##fileDate=20110705
##reference=1000GenomesPilot-NCBI37
##phasing=partial
##INFO=<ID=NS,Number=1,Type=Integer,Description="Number of Samples With Data">
##INFO=<ID=DP,Number=1,Type=Integer,Description="Total Depth">
##INFO=<ID=AF,Number=.,Type=Float,Description="Allele Frequency">
##INFO=<ID=AA,Number=1,Type=String,Description="Ancestral Allele">
##INFO=<ID=DB,Number=0,Type=Flag,Description="dbSNP membership, build 129">
##INFO=<ID=H2,Number=0,Type=Flag,Description="HapMap2 membership">
##FILTER=<ID=q10,Description="Quality below 10">
##FILTER=<ID=s50,Description="Less than 50% of samples have data">
##FORMAT=<ID=GQ,Number=1,Type=Integer,Description="Genotype Quality">
##FORMAT=<ID=GT,Number=1,Type=String,Description="Genotype">
##FORMAT=<ID=DP,Number=1,Type=Integer,Description="Read Depth">
##FORMAT=<ID=HQ,Number=2,Type=Integer,Description="Haplotype Quality">
#CHROM POS ID REF ALT QUAL FILTER INFO
2 4370 rs6057 G A 29 . NS=2;DP=13;AF=0.5;DB;H2
2 7330 . T A 3 q10 NS=5;DP=12;AF=0.017
2 110696 rs6055 A G,T 67 PASS NS=2;DP=10;AF=0.333,0.667;AA=T;DB
2 130237 . T . 47 . NS=2;DP=16;AA=T
2 134567 microsat1 GTCT G,GTACT 50 PASS NS=2;DP=9;AA=G
```

variants that are phased are inherited together (paternal)

| indicates phased variants

/ indicates non-phased variants

FORMAT	Sample1	Sample2
GT:GQ:DP:HQ	0 0:48:1:52,51	1 0:48:8:51,51
GT:GQ:DP:HQ	0 0:46:3:58,50	0 1:3:5:65,3
GT:GQ:DP:HQ	1 2:21:6:23,27	2 1:2:0:18,2
GT:GQ:DP:HQ	0 0:54:7:56,60	0 0:48:4:56,51
GT:GQ:DP	0/1:35:4	0/2:17:2

INFO section is for all samples combined

Sample1 haplotypes: GTGT and GTTT
 Sample2 haplotypes: ATTT and GAGT

Summarizing Variant Calls from Different Tools

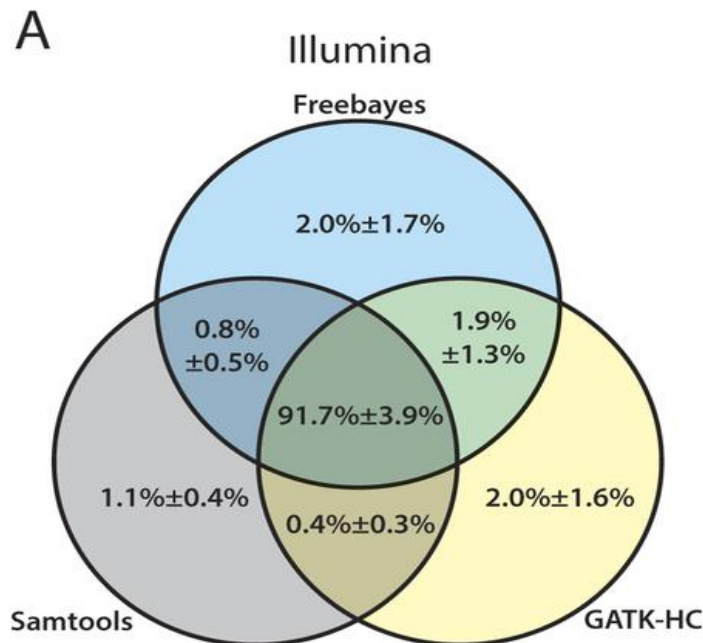

The mean percentage with standard deviation of confidence variant calls with equal to or higher than the quality score threshold of 20 are represented for (A) Illumina data sets

Huang et al 2015 doi:10.1038/srep17875

Consequence of Amino Acid Change

- Assess consequence of amino acid change based on sequence conservation across multiple species using the PROVEAN tool
- Variants with a score equal to or below -2.5 are considered “deleterious”

module spider PROVEAN

```
## PROVEAN v1.1 output ##
# Query sequence file:  CTRG_00013.fa
# Variation file:      CTRG_00013.var
# Protein database:   /scratch/datasets/blast/nr
[16:01:13] searching related sequences...
[16:16:36] clustering subject sequences...
# Number of clusters:    30
# Number of supporting sequences used: 245
[16:18:39] computing delta alignment scores...
## PROVEAN scores ##
# VARIATION SCORE
A431S   -0.455
E411K   -3.051
E226Q   -1.564
```

Verify that enough supporting sequences were found

“deleterious”

Annotate Variants

module spider snpEff

- A file of variant calls in vcf format is needed
- A reference sequence with gene annotations is needed
- snpEff annotates a vcf file
 - There are > 2,500 pre-built databases available and you can build your own if needed
 - Annotates MNP (multiple nucleotide polymorphism)
 - Codon change due to two SNPs: ACA → GGA

```
5          325795      .          AC          GG          23.8901      .
AB=0.428571;ABP=3.32051;AC=1;AF=0.5;AN=2;AO=3;CIGAR=2X;DP=7;DPB=7;DPRA=0;EPP=3.73412;
EPPR=3.0103;GTI=0;LEN=2;MEANALT=1;MQM=33;MQMR=48.5;NS=1;NUMALT=1;ODDS=5.49681;PAIRED=0;
PAIREDR=0.5;PAO=0;PQA=0;PQR=0;PRO=0;QA=114;QR=150;RO=4;RPL=3;RPP=9.52472;RPPR=3.0103;
RPR=0;RUN=1;SAF=2;SAP=3.73412;SAR=1;SRF=2;SRP=3.0103;SRR=2;TYPE=mnnp;technology.ILLUMINA=1;
ANN=GG|missense_variant|MODERATE|CD36_51230|CD36_51230|transcript|CAX41505.1|
protein_coding|1/1|c.1657_1658delACinsGG|p.Thr553Gly|1657/1851|1657/1851|553/616||
GT:DP:RO:QR:AO:QA:GL          0/1:7:4:150:3:114:-6.7054,0,-11.1847
```

Viewing SNPs in a Diploid Organism

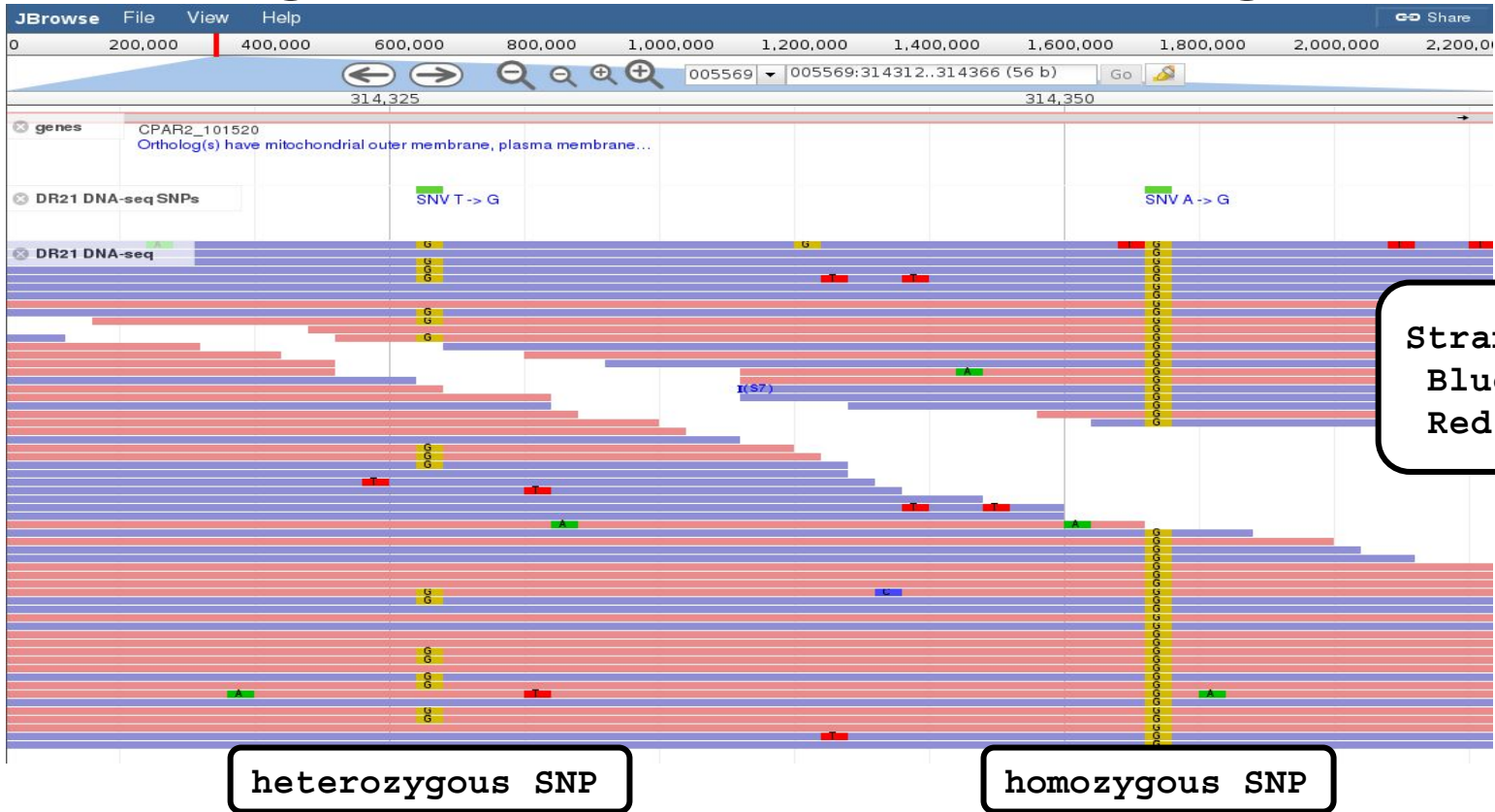

Example of Sequencing Strand Bias

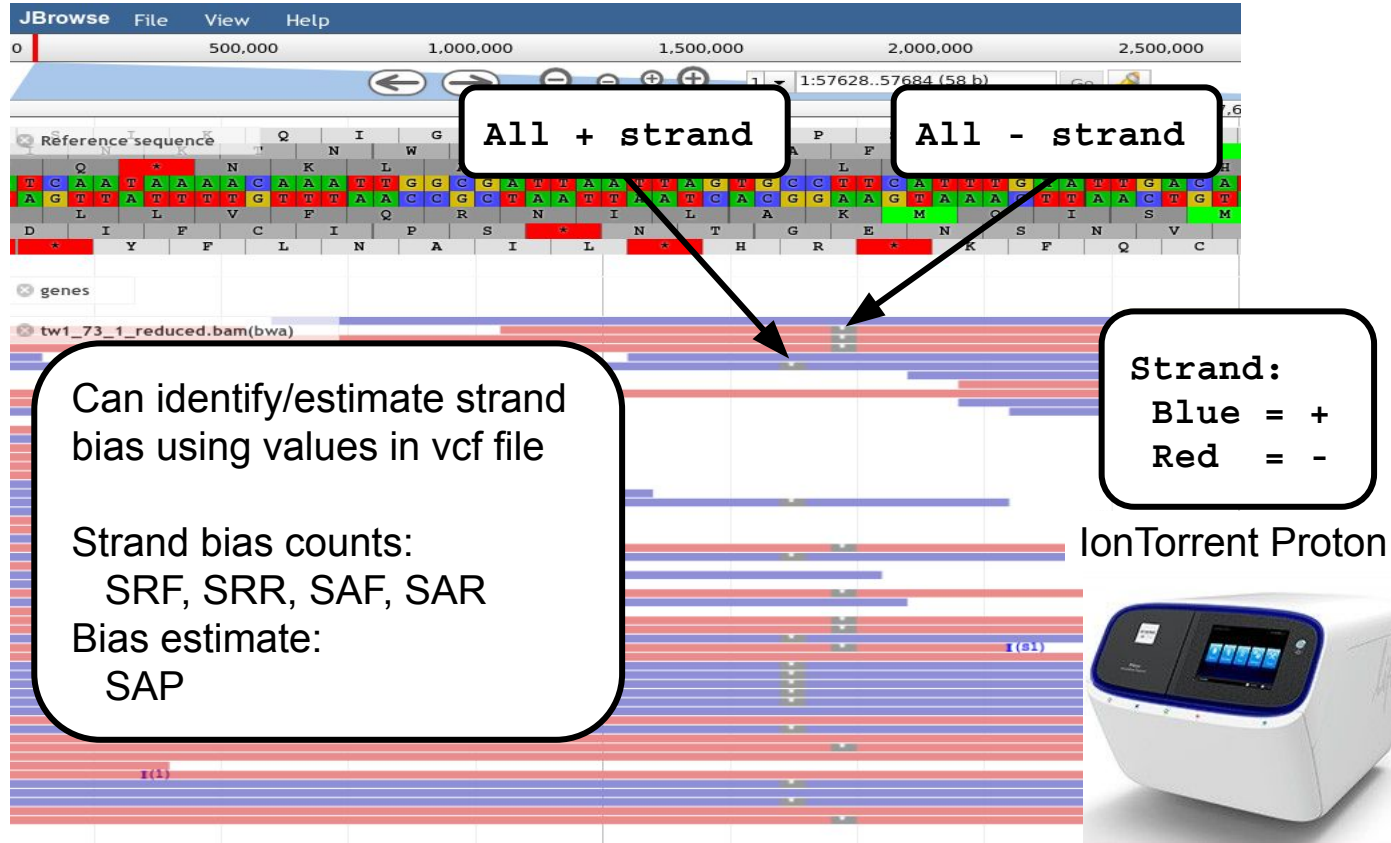

RNA-seq Overview

RNA-seq Applications

- Differential Expression (DE) and transcript abundance
 - HISAT2, STAR, TopHat, Cufflinks, Cuffmerge, Cuffdiff
 - DESeq and DESeq2 (R package)
 - EdgeR (R package)
- Transcriptome assembly (find isoforms and rare transcripts)
 - *de novo* (Trinity, Oases, SOAPdenovo-Trans)
 - reference based (Trinity, StringTie)
- Genome Annotation
 - Align to assembly for validation of gene models
- Variant Calling
 - STAR/Picard/GATK (Haplotype Caller (HC) in RNA-seq mode)
- *de novo* genome assembly scaffolding
 - L_RNA_scaffolder
- Identify fusion transcripts
 - tophat-fusion

Sequence Depth for RNA-seq Differential Expression

RNA-seq differential expression studies: more sequence or more replication?

Liu, Yuwen, Zhou, Jie and White, Kevin P. [Bioinformatics](#). 2014 Feb 1; 30(3): 301–304.
doi: [10.1093/bioinformatics/btt688](https://doi.org/10.1093/bioinformatics/btt688) PMID: PMC3904521

- Using more biological replicates instead of increasing sequencing depth resulted in improved accuracy of expression estimation
- Use more biological replicates at lower sequencing depth is more beneficial than fewer samples at a higher sequencing depth
- Increasing sequence depth is beneficial for exon or transcript-specific expression studies

RNA-seq Transcriptome Assembly

- Assembly with a reference genome

```
module spider Trinity
```

```
module spider HISAT2 Cufflinks
```

```
module spider Scripture
```

```
module spider StringTie
```

- *de novo* assembly without a reference genome

```
module spider Trinity
```

```
module spider Oases
```

Trinity – How it works:

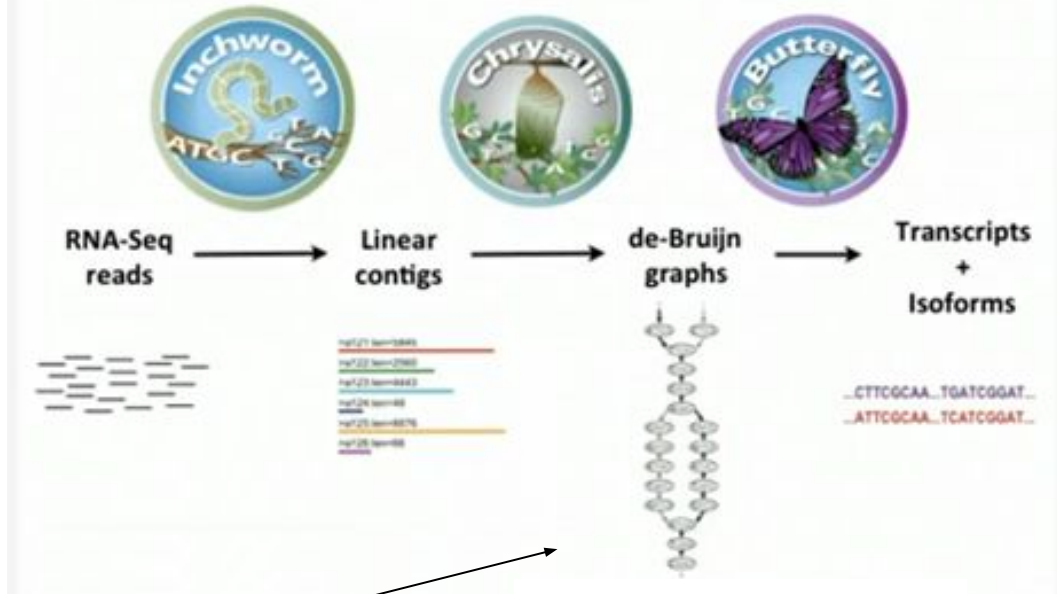

Thousands of disjoint graphs

ideally one graph per gene/transcript

Broad Institute

<https://www.broadinstitute.org/videos/introduction-de-novo-rna-seq-assembly-using-trinity>

Running Trinity on Grace

- Trinity creates 100,000s of intermediate files
 - Contact **help@hprc.tamu.edu** and request a file quota increase before running Trinity or use the \$TMPDIR in your job script
 - Run one Trinity job at a time and check resource usage
 - `showquota`
 - It is recommended not to run multiple Trinity jobs unless you are using \$TMPDIR
 - Trinity creates checkpoints and can be restarted if it stops due to file/disk quota met, out of memory or runtime
 - Checkpoints are not available when running Trinity in Galaxy
 - Checkpoints are not available if you use \$TMPDIR with Trinity
 - need to rsync results from \$TMPDIR at end of job script
 - checkpoints are stored in \$TMPDIR which is deleted after job ends
- See GCATemplates for sample Trinity scripts

ChIP-seq

Chromatin immunoprecipitation (ChIP) is a technique for identifying and characterizing elements in protein-DNA interactions involved in gene regulation or chromatin organization.

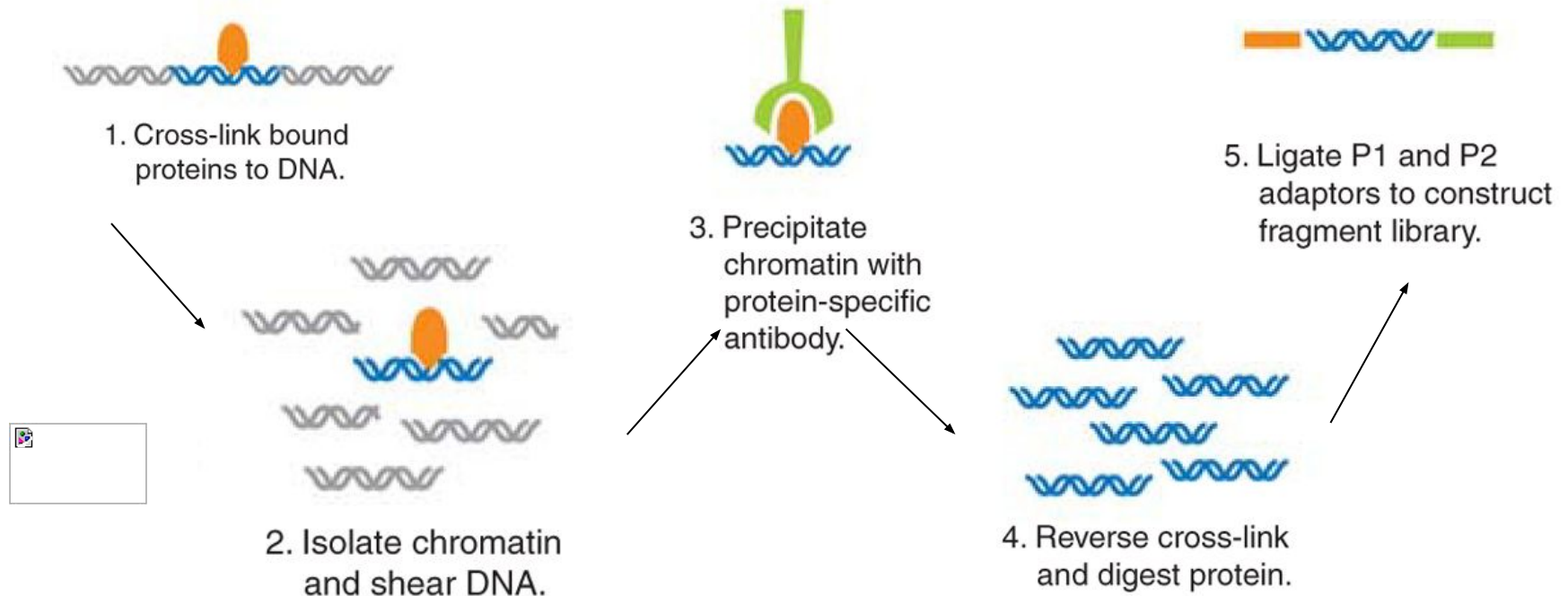

Chromatin immunoprecipitation sequencing (ChIP-Seq) on the SOLiD™ system
Nature Methods 6, (2009)

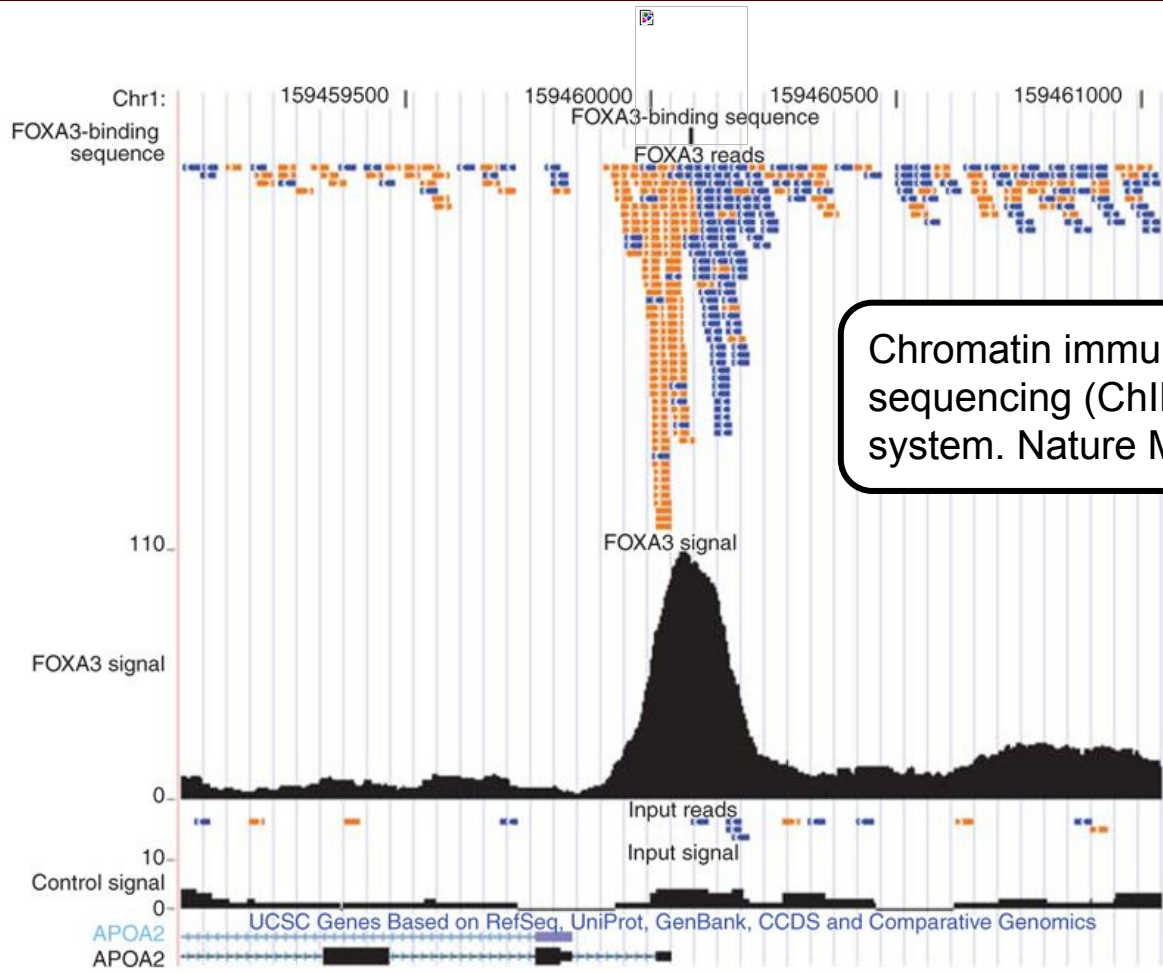

Chromatin immunoprecipitation sequencing (ChIP-Seq) on the SOLiD™ system. Nature Methods 6, (2009)

The goal is to find a consensus DNA sequence among the sequences at each peak which will give us the DNA sequence motif that a protein recognizes and binds

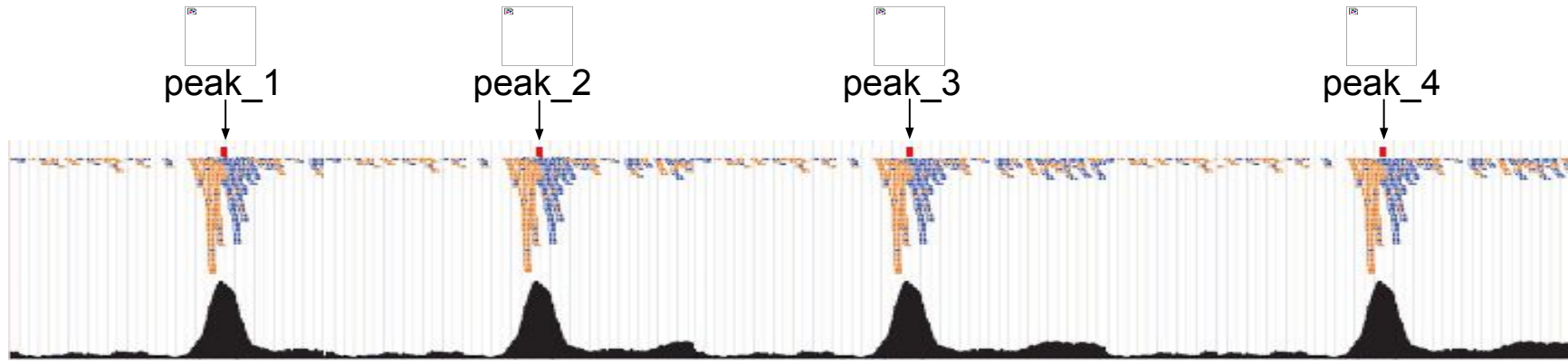

A sequence logo can be used to represent the DNA sequence motif where the protein binds

Generate a sequence logo with the R package seqLogo

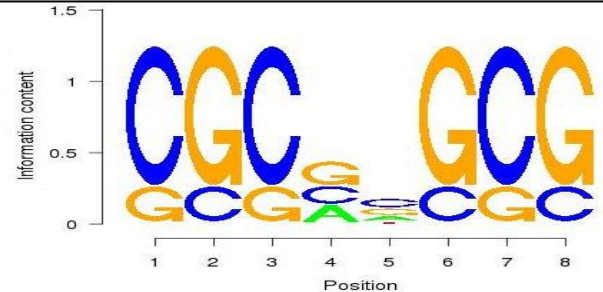

```
module load iccifort/2020.4.304 impi/2019.9.304 R_tamu/4.1.0
```

ChIP-seq Tools

- Protein-DNA interactions
 - `module spider MACS`
 - `module spider MACS2`
- Subdivision of ChIP-seq regions into discrete signal peaks
 - `module spider PeakSplitter`
- Peak caller
 - `module spider PeakRanger`
 - `module spider BroadPeak`
- Identify enriched domains from histone modification ChIP-seq data
 - `module spider SICER`

HPRC Portal Interactive Apps

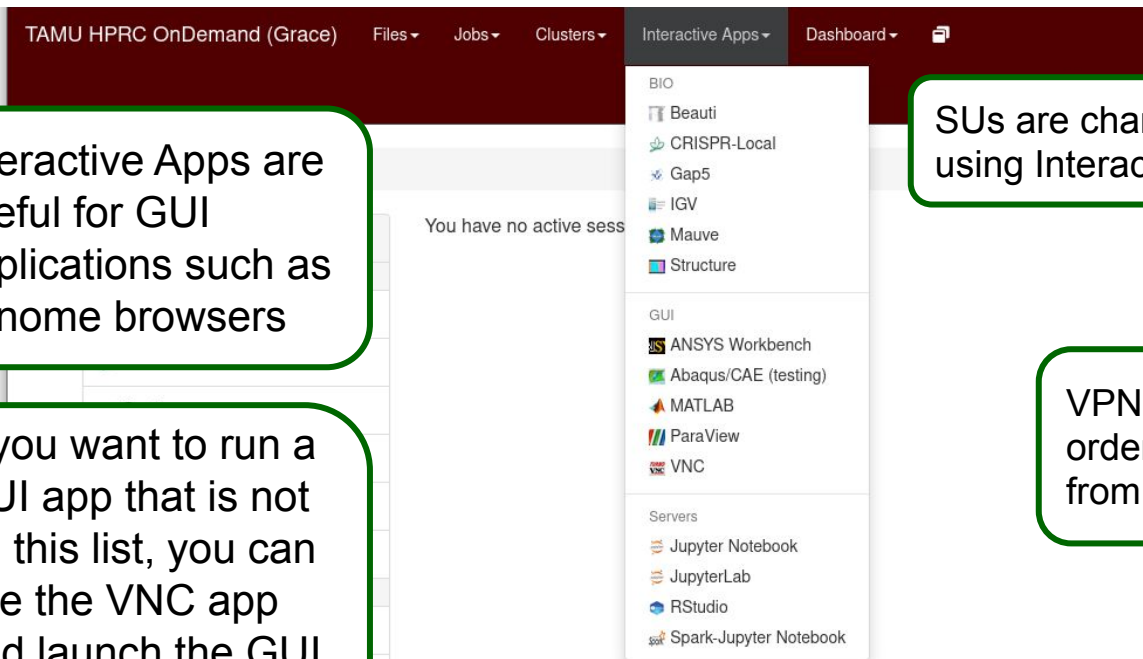

Interactive Apps are useful for GUI applications such as genome browsers

If you want to run a GUI app that is not on this list, you can use the VNC app and launch the GUI from the VNC terminal

SUs are charged for using Interactive Apps

VPN must be running in order to access the portal from off campus

portal-grace.hprc.tamu.edu

TAMUlauncher

```
blastn -query chunk0000.fa -db 'nt.bacteria' -task megablast -out chunk0000.fa.out -outfmt 6
blastn -query chunk0001.fa -db 'nt.bacteria' -task megablast -out chunk0001.fa.out -outfmt 6
blastn -query chunk0002.fa -db 'nt.bacteria' -task megablast -out chunk0002.fa.out -outfmt 6
blastn -query chunk0003.fa -db 'nt.bacteria' -task megablast -out chunk0003.fa.out -outfmt 6
blastn -query chunk0004.fa -db 'nt.bacteria' -task megablast -out chunk0004.fa.out -outfmt 6
blastn -query chunk0005.fa -db 'nt.bacteria' -task megablast -out chunk0005.fa.out -outfmt 6
blastn -query chunk0006.fa -db 'nt.bacteria' -task megablast -out chunk0006.fa.out -outfmt 6
blastn -query chunk0007.fa -db 'nt.bacteria' -task megablast -out chunk0007.fa.out -outfmt 6
blastn -query chunk0008.fa -db 'nt.bacteria' -task megablast -out chunk0008.fa.out -outfmt 6
blastn -query chunk0009.fa -db 'nt.bacteria' -task megablast -out chunk0009.fa.out -outfmt 6
blastn -query chunk0010.fa -db 'nt.bacteria' -task megablast -out chunk0010.fa.out -outfmt 6
blastn -query chunk0011.fa -db 'nt.bacteria' -task megablast -out chunk0011.fa.out -outfmt 6
blastn -query chunk0012.fa -db 'nt.bacteria' -task megablast -out chunk0012.fa.out -outfmt 6
blastn -query chunk0013.fa -db 'nt.bacteria' -task megablast -out chunk0013.fa.out -outfmt 6
blastn -query chunk0014.fa -db 'nt.bacteria' -task megablast -out chunk0014.fa.out -outfmt 6
blastn -query chunk0015.fa -db 'nt.bacteria' -task megablast -out chunk0015.fa.out -outfmt 6
blastn -query chunk0016.fa -db 'nt.bacteria' -task megablast -out chunk0016.fa.out -outfmt 6
blastn -query chunk0017.fa -db 'nt.bacteria' -task megablast -out chunk0017.fa.out -outfmt 6
blastn -query chunk0018.fa -db 'nt.bacteria' -task megablast -out chunk0018.fa.out -outfmt 6
blastn -query chunk0019.fa -db 'nt.bacteria' -task megablast -out chunk0019.fa.out -outfmt 6
blastn -query chunk0020.fa -db 'nt.bacteria' -task megablast -out chunk0020.fa.out -outfmt 6
blastn -query chunk0021.fa -db 'nt.bacteria' -task megablast -out chunk0021.fa.out -outfmt 6
blastn -query chunk0022.fa -db 'nt.bacteria' -task megablast -out chunk0022.fa.out -outfmt 6
blastn -query chunk0023.fa -db 'nt.bacteria' -task megablast -out chunk0023.fa.out -outfmt 6
```

tamulauncher

compute node 1

compute node 2

compute node 3

compute node 4

compute node 5

- A convenient way to run a large number of single core jobs
- Available for use from the Unix command line and Galaxy (BLAST+)
- Only need to submit one job instead of many small jobs
- Useful for submitting thousands of BLAST jobs

Biocontainers

<https://biocontainers-edu.readthedocs.io/en/latest/index.html>

What is a Biocontainer?

- A biocontainer is a container that has one or more bioinformatics software packages installed
- A container is a single image file that contains one or more installed software components
- Docker or Singularity is used to build and access a biocontainer
- A container does not contain the entire OS, just components to complement the host OS for running software installed in the container

Pros

- Software is already installed with a specific version together with all software dependencies
- The biocontainer is just one file compared to a software module or conda environment which can have thousands of files

Cons

- The latest software version of a bioinformatics tool may not have a biocontainer available
- Software dependencies within a container may not be the version you want to use

Using Biocontainers on HPRC Clusters

1. Docker is not available on HPRC clusters but Singularity is available
2. Docker images must be converted to a Singularity image
3. Singularity is only available on compute nodes not login nodes
4. Compute nodes do not have internet access but you can enable a proxy configuration in order to download biocontainers
5. Use VNC portal app or srun to access command line on a compute node in order to convert Docker container to a Singularity image
6. Once you have your biocontainer converted to Singularity, you can run it from within a job script

<https://hprc.tamu.edu/wiki/Bioinformatics:Biocontainers>

Finding Biocontainers

<https://hub.docker.com/u/biocontainers>

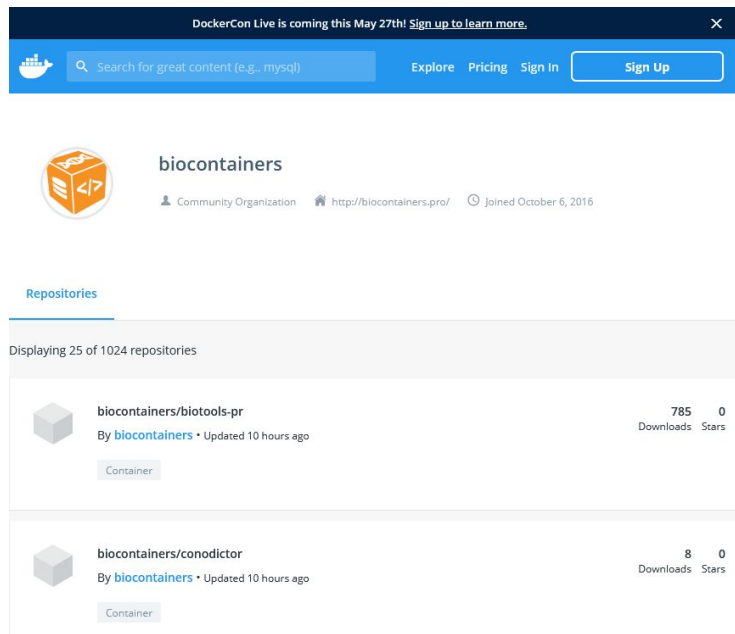

DockerCon Live is coming this May 27th! [Sign up to learn more.](#)

Search for great content (e.g., mysql) Explore Pricing Sign In Sign Up

biocontainers
Community Organization <http://biocontainers.pro/> Joined October 6, 2016

Repositories

Displaying 25 of 1024 repositories

Repository	Downloads	Stars
biocontainers/biotools-pr By biocontainers • Updated 10 hours ago Container	785	0
biocontainers/conductor By biocontainers • Updated 10 hours ago Container	8	0

<https://quay.io>

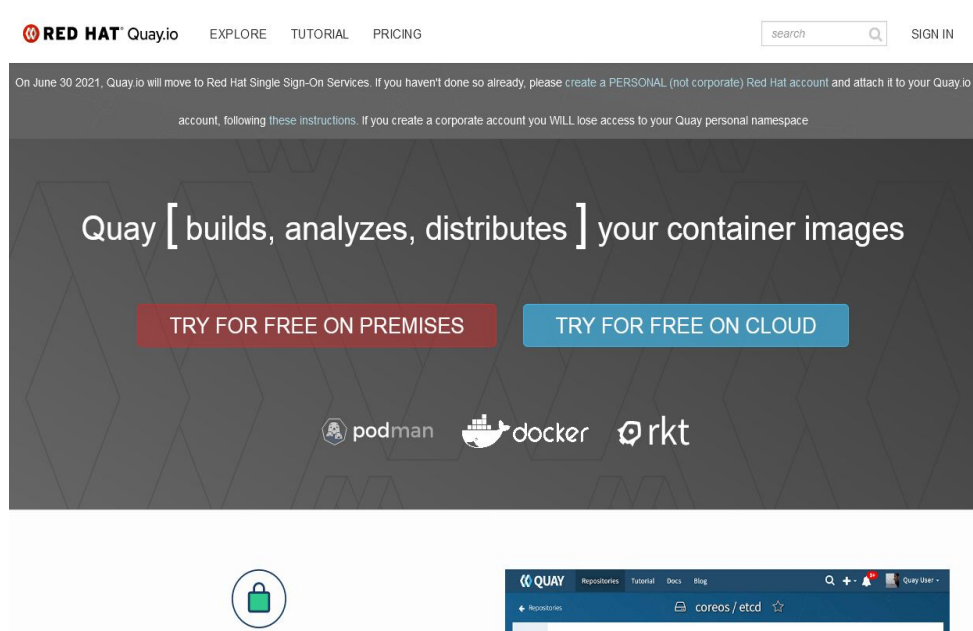

RED HAT Quay.io EXPLORE TUTORIAL PRICING

search SIGN IN

On June 30 2021, Quay.io will move to Red Hat Single Sign-On Services. If you haven't done so already, please create a PERSONAL (not corporate) Red Hat account and attach it to your Quay.io account, following these instructions. If you create a corporate account you WILL lose access to your Quay personal namespace

Quay [builds, analyzes, distributes] your container images

TRY FOR FREE ON PREMISES TRY FOR FREE ON CLOUD

podman docker rkt

QUAY Repositories Tutorial Docs Blog

Repositories coreos/etcd

Build the Singularity Biocontainer

1. Connect to a compute node using the HPRC portal VNC app, srun interactive job or run as a job script

```
srun --time=01:00:00 --mem=14G --ntasks=1 --cpus-per-task=2 --pty bash
```

2. Run the following on the compute node command line to enable proxy for internet connection

```
module load WebProxy
```

3. Images can be large during the conversion from Docker to Singularity. Run the following:

```
export SREGISTRY_DATABASE=$TMPDIR  
export SINGULARITY_CACHEDIR=$TMPDIR
```

4. The following will create a Singularity image from an available Docker container and name it blast_2.2.31.sif (takes about 4 minutes to download with 2 CPUs and convert the blast container)

```
singularity pull docker://biocontainers/blast:2.2.31
```

https://hprc.tamu.edu/wiki/SW:Singularity#Singularity_pull_examples

Singularity Build Time

blast_2.2.31.sif	#SBATCH cpus	#SBATCH memory	time to build .sif file
build 1	2 cores	4 GB	3 min 45 sec
build 2	28 cores	54 GB	2 min

```
#!/bin/bash
#SBATCH --export=NONE           # do not export current env to the job
#SBATCH --job-name=singularity # job name
#SBATCH --time=01:00:00        # max job run time dd-hh:mm:ss
#SBATCH --ntasks-per-node=1    # tasks (commands) per compute node
#SBATCH --cpus-per-task=2      # CPUs (threads) per command
#SBATCH --mem=4G               # total memory per node
#SBATCH --output=stdout.%j     # save stdout to file (%j is jobid)
#SBATCH --error=stderr.%j      # save stderr to file (%j is jobid)
```

```
module load WebProxy
export SREGISTRY_DATABASE=$TMPDIR
export SINGULARITY_CACHEDIR=$TMPDIR
singularity pull docker://biocontainers/blast:2.2.31
```

Test the Singularity Biocontainer

Enter the following in the same directory as the .sif file to see the help info for the blastp command

```
singularity exec blast_2.2.31.sif blastp -h
```

Or run the following will launch a prompt which you can use to explore the commands available in the container. This is not used to update the image with new or additional software.

```
singularity run blast_2.2.31.sif
```

type `exit` to exit the Singularity> prompt

Run the Singularity Biocontainer

Example command to run on the compute node command line or put into a job script

```
singularity exec blast_2.2.31.sif blastp -query seqs.fa -db hg19 -out blastout.csv -num_threads $SLURM_CPUS_PER_TASK
```

Or if your .sif file is in a different directory than the working directory

```
singularity exec /sw/hprc/sw/bio/containers/blast_2.2.31.sif blastp -query seqs.fa -db hg19 -out blastout.csv -num_threads 28
```

type **exit** to exit the srun interactive job

<https://hprc.tamu.edu/wiki/Bioinformatics:Biocontainers>

Useful alias commands for your ~/.bashrc

list files newest to oldest

```
alias lhl='ls -lsth'  
alias lh='ls -lsth | head'  
alias lhh='ls -lsth | head -20'  
alias lh hh='ls -lsth | head -30'
```

show your running jobs

```
alias q='squeue -u $USER'  
alias p='pstat -u $USER'
```

HPRC Resources

- Free Help
 - Send an email to help@hprc.tamu.edu if you have any questions regarding Bioinformatics tools usage on HPRC clusters or to schedule a Zoom or in-person visit
 - First spend some time investigating the error
 - read log files, stdout file, stderr file, tool manual
 - Google search
 - Google user groups: many are software specific
 - Include details about your issue
 - The JobID
 - Which cluster or which Galaxy you are using
 - Which software you are using
 - Which modules you have loaded
 - Commands you used in your job script
 - Error messages you are seeing
- HPRC NGS data analysis tools Documentation
 - <https://hprc.tamu.edu/wiki/Bioinformatics>

Let us know when the issue has been resolved so we can close the helpdesk ticket